



SNOWALL
SNOWALL MAXI
Caimi Lab

1 SNOWALL - FIBER 3 MELANGE

design Caimi Lab
Snowsound® Extra

7SWT/M-xxx

118"

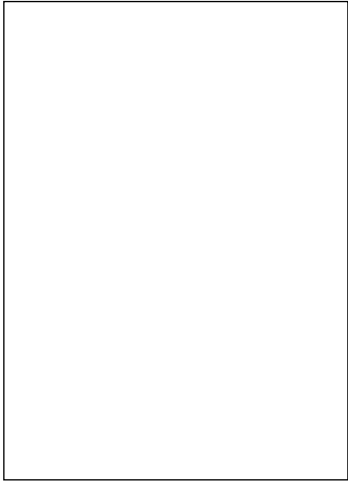

42 sqft

51" (± 1")

Available Colors

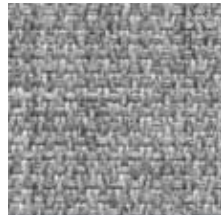

300



302

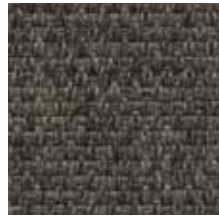

303

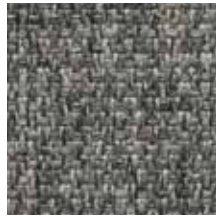

304

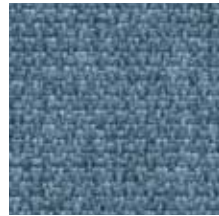

305



308



309

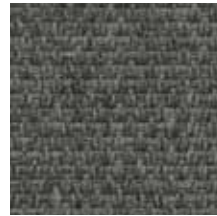

311



313



314

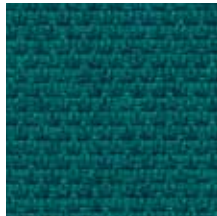

315



316



317

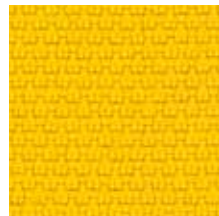

318



319



320

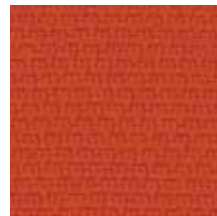

321



322

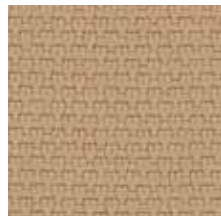

323



324



325



326

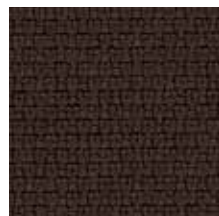

327

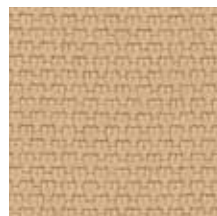

328

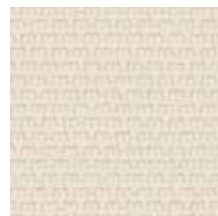

329

How to Order: 1) select panel code 2) select panel color (XXX) 3) indicate the quantity

DESCRIPTION

Flexible sound-absorbing panel.

The panel is composed of polyester fibers covered on the front with a Snowsound Fiber 3 Melange polyester fabric and on the back with a Velcro-compatible polyester fabric. Customers can also attach the panels to the wall with nails, staples or Velcro (fastening systems are not supplied). If you are using glues or adhesives, see p. 14
Panels can be positioned alongside each other to maintain the continuity of the design and can be cut onsite to adapt to different installation requirements.

SNOWALL - FIBER 8 BOUCLE'

7SWT/B-xxx

118"

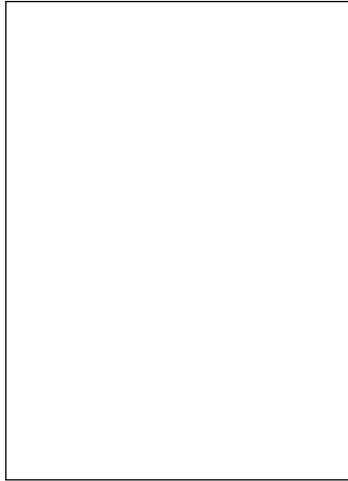

42 sqft

51" (± 1")

Available Colors



800



801



802



803

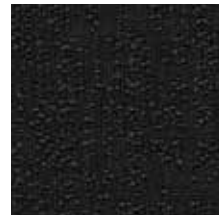

807



810



811



812



813

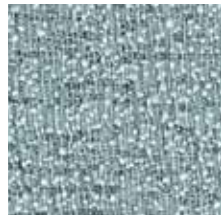

814

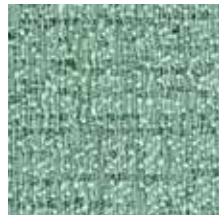

815



816

How to Order: 1) select panel code 2) select panel color (XXX) 3) indicate the quantity

DESCRIPTION

Flexible sound-absorbing panel.

The panel is composed of polyester fibers covered on the front with a Snowsound Fiber 8 Bouclé polyester fabric and on the back with a Velcro-compatible polyester fabric.

Customers can also attach the panels to the wall with nails, staples or Velcro (fastening systems are not supplied). If you are using glues or adhesives, see p. 14

Panels can be positioned alongside each other to maintain the continuity of the design and can be cut onsite to adapt to different installation requirements.

5 **SNOWALL MAX - FLUTED**

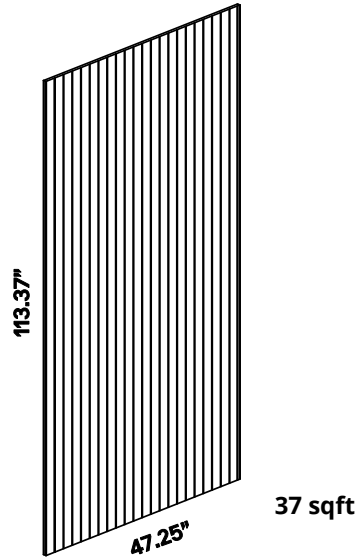

Semi rigid sound-absorbing panel. The panel is composed of polyester fibres covered on the front with a Snowsound Fiber 3 Melange polyester fabric. Customers can also attach the panels to the wall with nails or staples (fastening systems are not supplied). If you are using glues or adhesives, see p. 12. Panels can be positioned alongside each other to maintain the continuity of the design.

Panels available colors

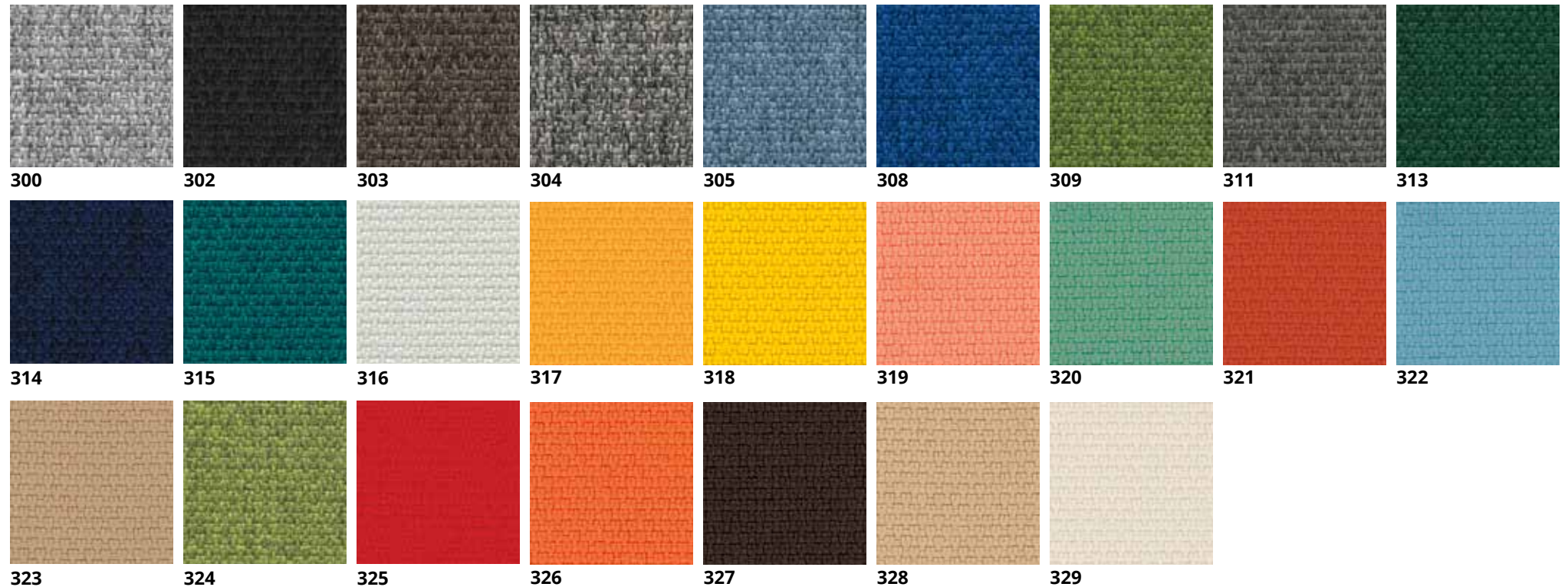

Minimum order 2 pieces

2 - 9 pieces

7SWLG/M-xxx

ChUbxUfXdfjW Zcf di fWUgYgcZ&hc :- 'd]YVWg]b h\YgUa YWt'cf

10 - 19 pieces

7SWLG/M-xxx

Discounted price for purchases of 10 to 19 pieces in the same color

≥ 20 pieces

7SWLG/M-xxx

Volume price for purchases of 20 pieces and above in the same color



To place order: 1) select panel code 2) select panel color (XXX) 3) indicate the quantity

Requested down payment: 60%

SNOWALL MAX - WAVY

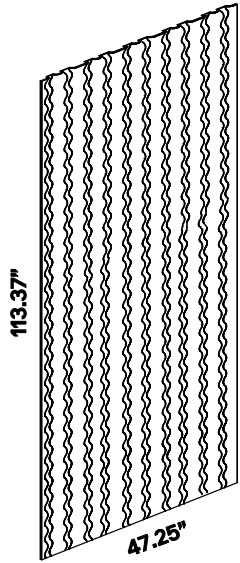

37 sqft

Semi rigid sound-absorbing panel. The panel is composed of polyester fibres covered on the front with a Snowsound Fiber 3 Melange polyester fabric. Customers can also attach the panels to the wall with nails or staples (fastening systems are not supplied). If you are using glues or adhesives, see p.12. Panels can be positioned alongside each other to maintain the continuity of the design.

Available Colors

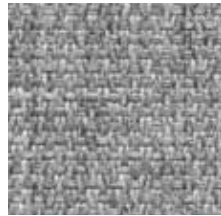

300



302



303

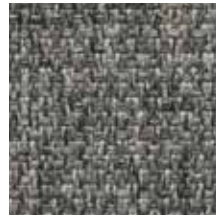

304

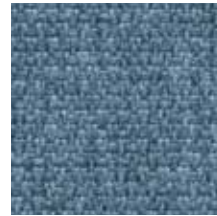

305



308



309

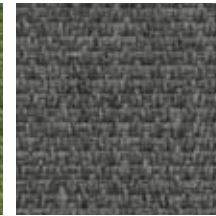

311



313



314

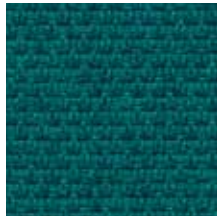

315



316



317

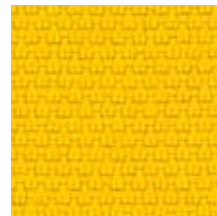

318



319

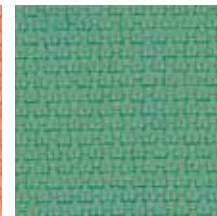

320



321



322

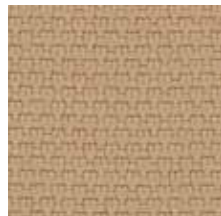

323



324



325



326

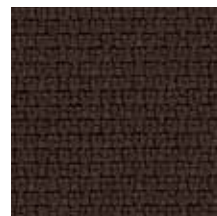

327

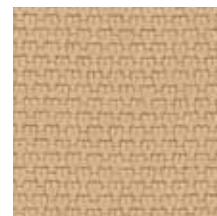

328

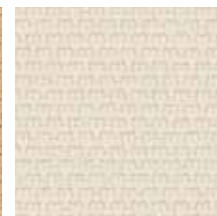

329

Minimum order 2 pieces

2 - 9 pieces
7SWFG/M-xxx

Standard price for purchases of 2 to 9 pieces in the same color

10 - 19 pieces
7SWFG/M-xxx

Discounted price for purchases of 10 to 19 pieces in the same color

≥ 20 pieces
7SWFG/M-xxx

Volume price for purchases of 20 pieces and above in the same color



To place order: 1) select panel code 2) select panel color (XXX) 3) indicate the quantity

Requested down payment: 60%

CUT - CUT - CUT - CUT - CUT



The panel can be cut to size: vertical pitch 3 cm, horizontal at the desired height, pitch 1 cm. Tolerance 3 mm.
This is only for vertical or horizontal cuts per panel

1.18"

CUT - CUT - CUT - CUT - CUT



The panel can be cut to size: vertical pitch 6 cm, horizontal at the desired height, pitch 1 cm. Tolerance 3 mm.
This is only for vertical or horizontal cuts per panel

2.36"



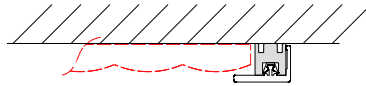
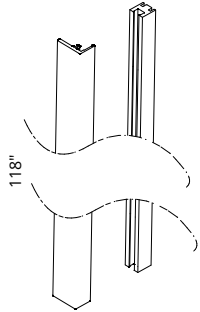

7SWPT-N
Matte black

End profile in aluminium for panels 7SWCAN-XXX and 7SWFRI-XXX **complete with counter-profile** for attaching to wall. Can be used on all sides of the panel, lateral, upper and lower. The profile facilitates the assembly of the panels and can be cut to size to adapt more easily to spaces.

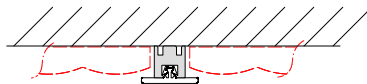
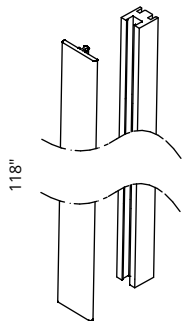
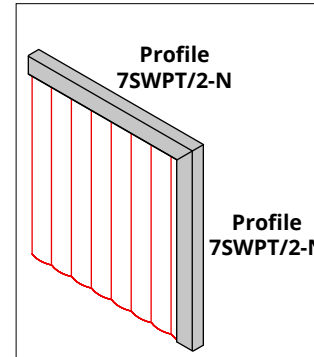
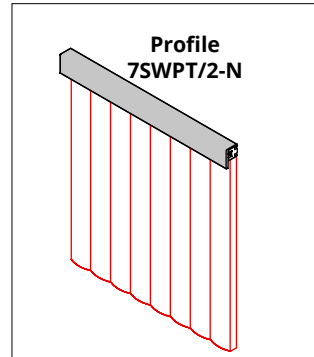
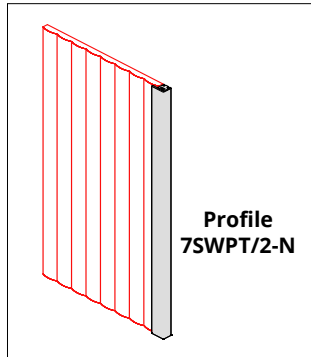

7SWPI-N
Matte black

Intermediate profile in aluminium for panels 7SWCAN-XXX and 7SWFRI-XXX **complete with counter-profile** for attaching to wall. The profile facilitates the assembly of the panels and can be cut to size to adapt more easily to spaces.

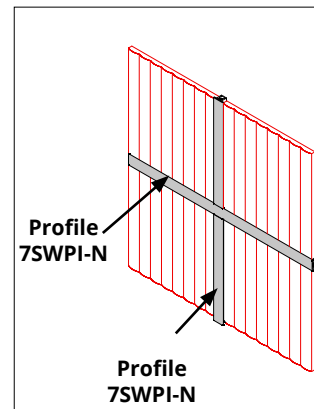
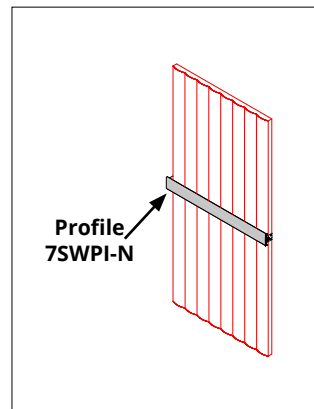
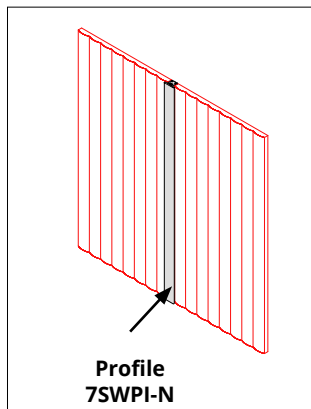

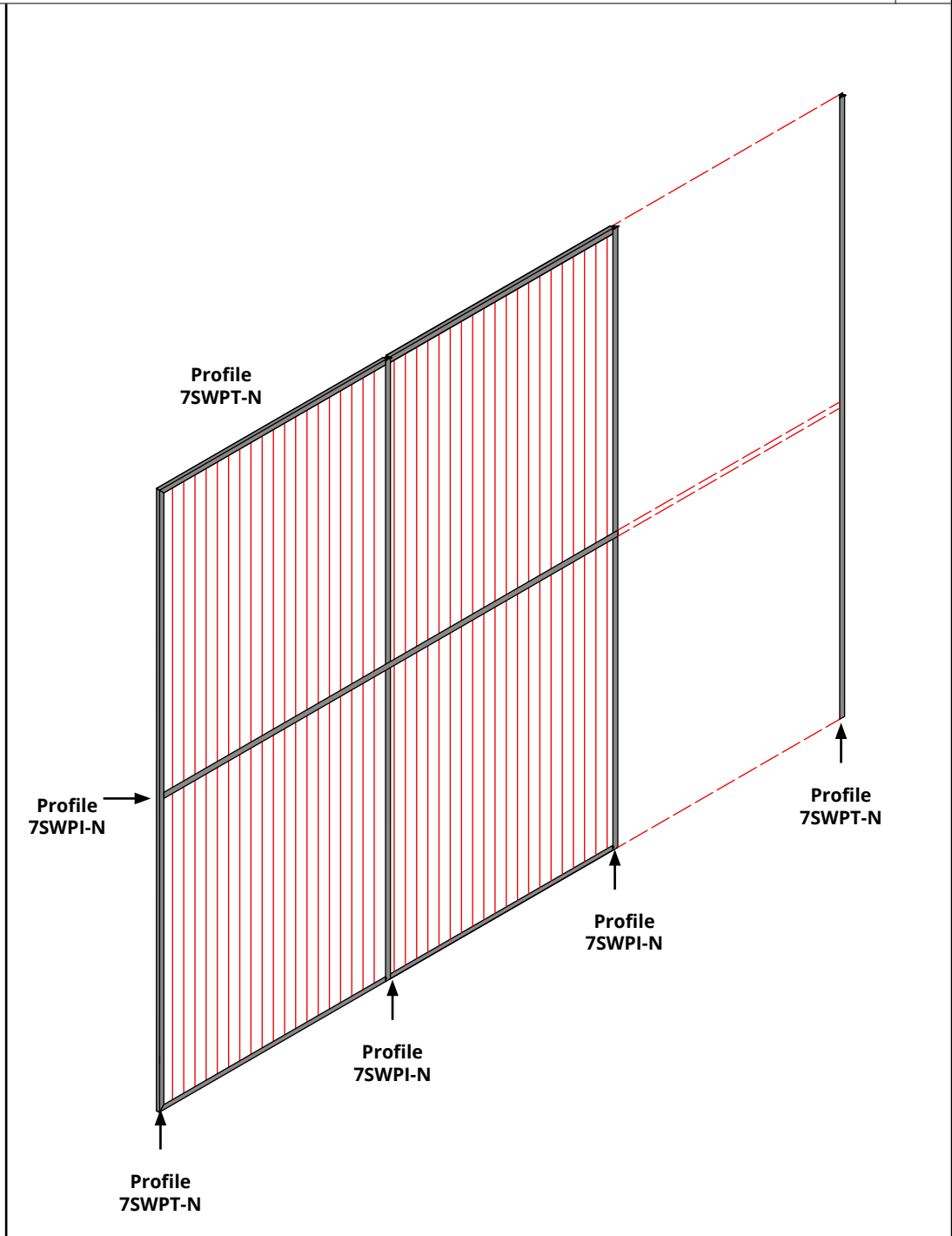
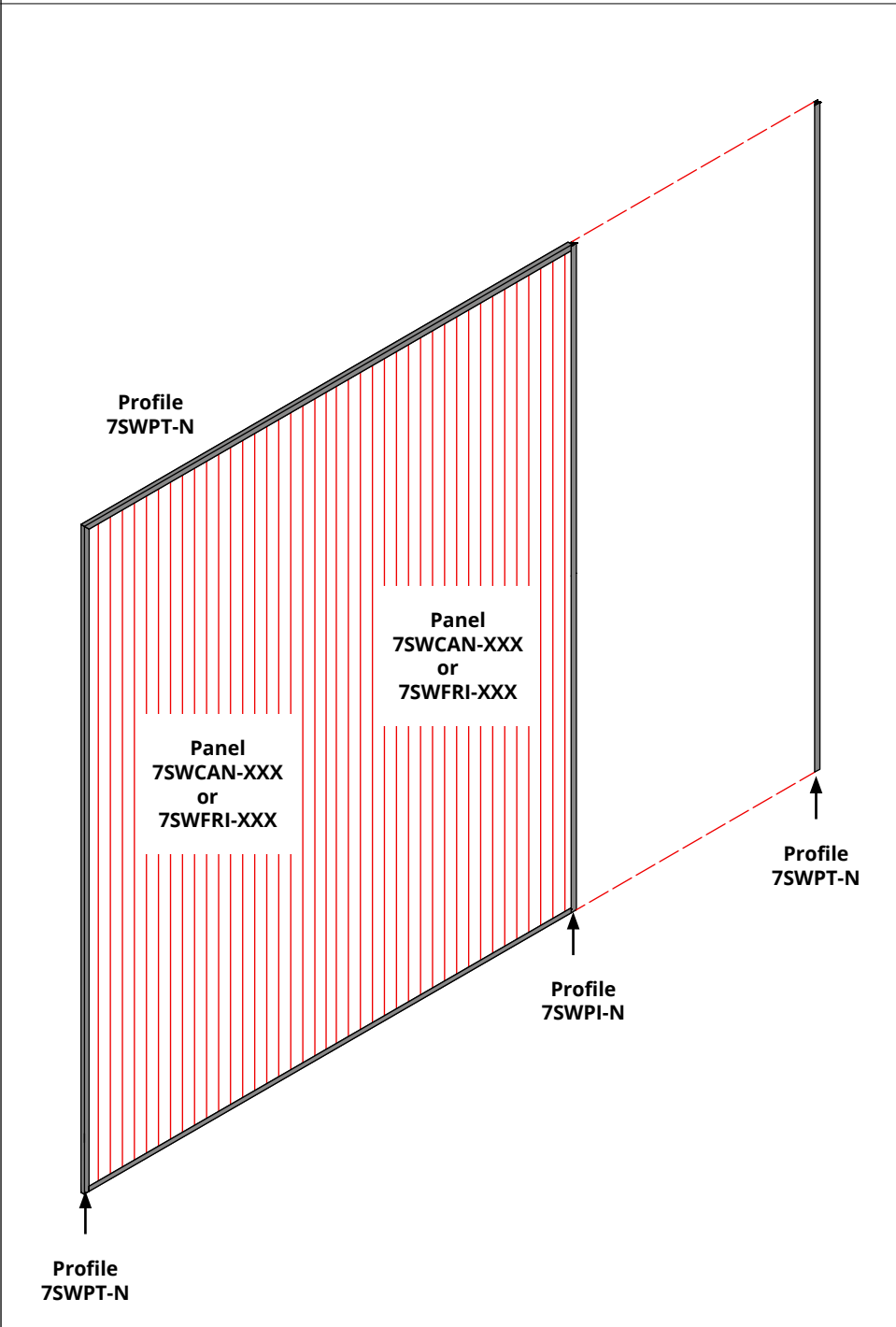

7SWPT-N - End profile with counterplate

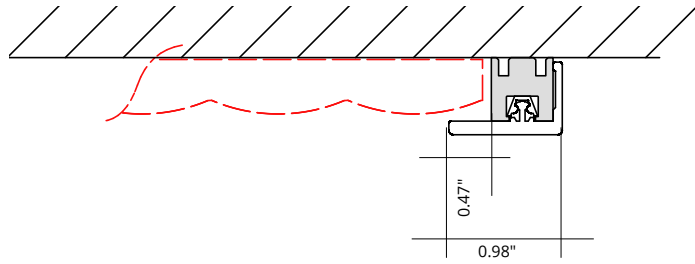

7SWPI-N - Intermediate profile with counterplate

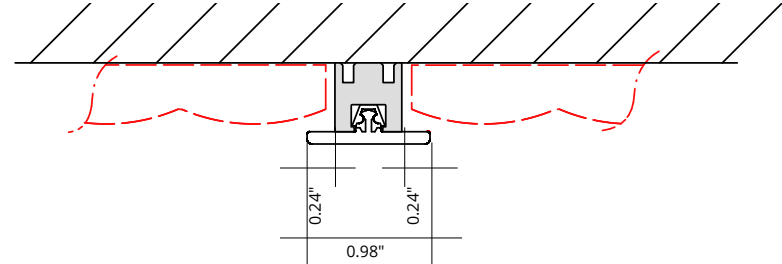

Wall profiles are pre-drilled at 7.28" spacing

If using glues and/or adhesives, check in advance that they are compatible with and suitable for the chosen location, the installation methods, the type of application and the end purpose, and that they comply with all codes and standards in the place of installation and applicable to specific cases.

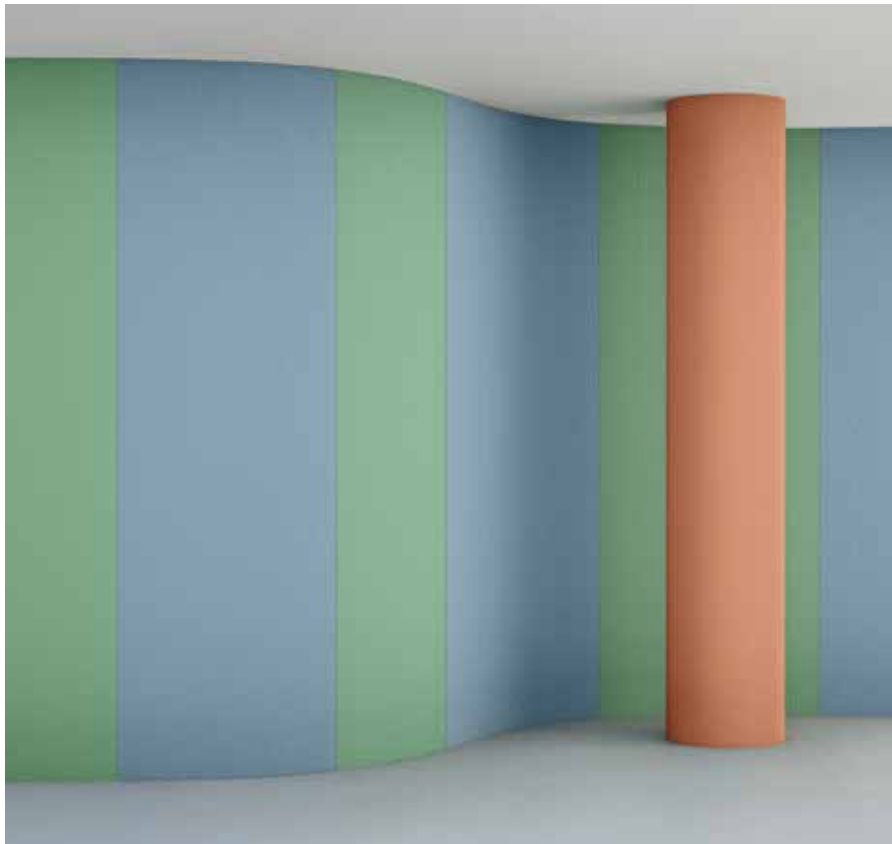

WARNINGS

- Before installing the products, check the bearing capacity of the wall/floor/surface on which the products will be positioned, ensuring they are suitable for the intended type of user/use.
- Installation must be performed exclusively by a qualified installer following said installer's confirmation that the structure has been correctly designed and that all individual components to be applied are compatible, also with regard to applicable rules and regulations in the place of installation.
- The products are not suitable for use by children.
- The products are not suitable for use outside.
- If the products are applied to the wall/floor/ceiling/surface, they must be installed with anchoring devices (not shown in the catalogue).
- The products must be assembled and/or installed exclusively by skilled technical personnel, using instruments and tools appropriate for this purpose.
- Carefully read the instructions enclosed with the product before proceeding with assembly and installation, paying particular attention to the warnings and to the explanatory drawings; if the instructions are not attached, contact the vendor's technical office.
- Suitable attachment devices must be used to attach the products to the wall/floor/surfaces, which are strong enough to resist the forces generated; in any case, suitable supporting elements to support each individual element must be used.
- In the case of incorrect installation and/or weights exceeding the maximum loads indicated on this price list and/or the instructions attached to the individual products, a situation of danger could be created, the products could collapse, fall and cause damage to people and/or things: never exceed the loads indicated.
- Do not install the product in the case of any doubts over the methods of installation and/or bearing capacity of the wall/floor/surface on which the product is to be positioned.
- Comply with the instructions and compositions shown on this price list; for different compositions and/or further information on the products or installation methods, contact the vendor's technical office.
- Slight color differences between one lot and another have to be considered normal, within usual tolerances usually accepted for industrial productions.
- The authentic text is only in Italian, the translation has the mere purpose of simplifying the reading.