

# PLI OVERSIZE

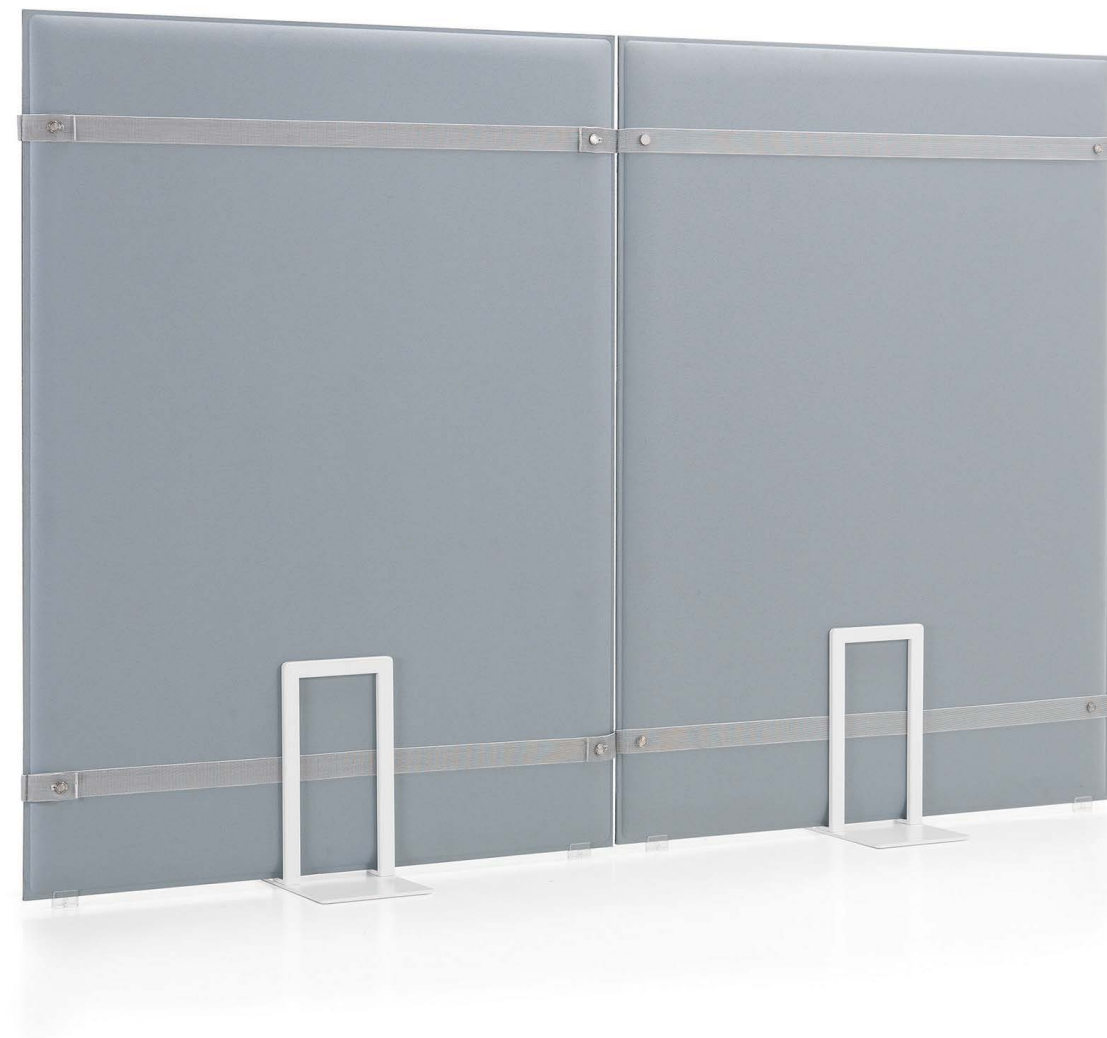

# PLI OVERSIZE

The PLI OVERSIZE system is characterized by large-size acoustic panels crafted with Snowsound® technology. These panels serve as double-sided free-standing partitions with a 1.0 NRC (Noise Reduction Coefficient).









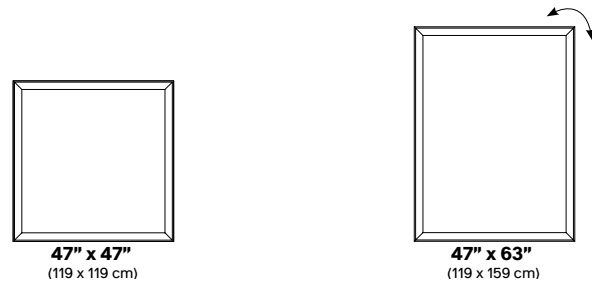

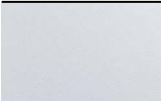
|               |   |
|---------------|---|
| <b>Specs</b>  | <b>Polyester internal padding with Snowsound technology, polyester covering in Trevira CS® fabric</b> |
|               | <b>Single material and 100% recyclable</b>  |
|               | <b>Eco friendly – Greenguard Gold</b>   |
|               | <b>Durable, tackable double-sided surface</b>   |
|               | <b>Patented variable density composition</b>  |
|               | <b>Class A sound absorption with NRC 1.0 (ISO 354/ASTM C423/ISO 11654)</b>                            |
|               | <b>Absorbs 94% of human speech frequencies</b>  |
|               | <b>Class A fire and smoke safety (UL 723/ASTM E84)</b>  |
|               | <b>CAL 133, 117 pass</b>  |
|               | <b>Sleek profile at only 1.4” thick</b>   |
|               | <b>Freestanding</b>   |
| <b>Design</b> | <b>Marc Sadler</b>  |





# PLI OVERSIZE PANELS

Call your representative for stock levels and availability

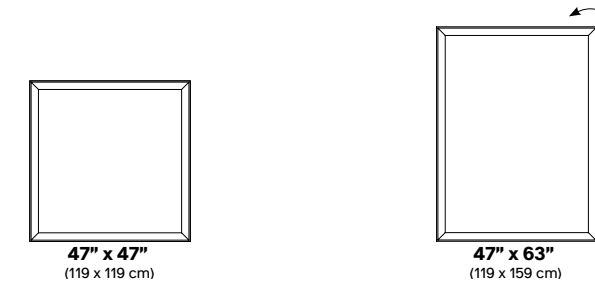

|  | Color            | Part No    | Part No    |
|--|------------------|------------|------------|
|    | White            | 40025042   | 40025045   |
|    | Silver<br>Gray   | 40025043   | 40025046   |
|    | Charcoal<br>Gray | 40025082   | 40025080   |
|    | Slate<br>Blue    | 40025299   | 40025300   |
|   | Beige            | 40025313** | 40025314** |
|  | Sun<br>Yellow    | 40025316** | 40025240** |
|  | Carrot<br>Orange | 40025311** | 40025241** |
|  | Red              | 40025315** | 40025284** |
|  | Rustic           | 40025291** | 40025292** |



|   | Color          | Part No                        | Part No                        |
|---|----------------|--------------------------------|--------------------------------|
|  | Olive<br>Green | 40025318**                     | 40025319**                     |
|  | Dark<br>Teal   | 40025307**                     | 40025308**                     |
|  | Cool<br>White  | 40025309**                     | 40025310**                     |
|  | Black          | 40025733**                     | 40025734**                     |
|   |                | Special Order Color<br>MOQ: 18 | Special Order Color<br>MOQ: 18 |

\*\* Extended lead time  
 Extended lead time colors require: up to 10–12 weeks  
 For larger swatches & full color options, please refer to pages 32–34.  
 Please specify panel stand separately refer to page 218

Panels available in special order colors. Special order colors require:  
 – MOQ varies from size to size  
 – Lead time up to 14–16 weeks  
 – +10% Custom service fee

# PLI OVERSIZE

## STAND - HARDWARE ONLY

| Panels  | Holds both sizes  | Holds both sizes  |
|---------|-------------------|-------------------|
| Part No | 40025123          | 40025122          |
| QTY     | 01 Stand, 02 Feet | 01 Stand, 02 Feet |
| Finish  | Silver Gray       | Matte White       |

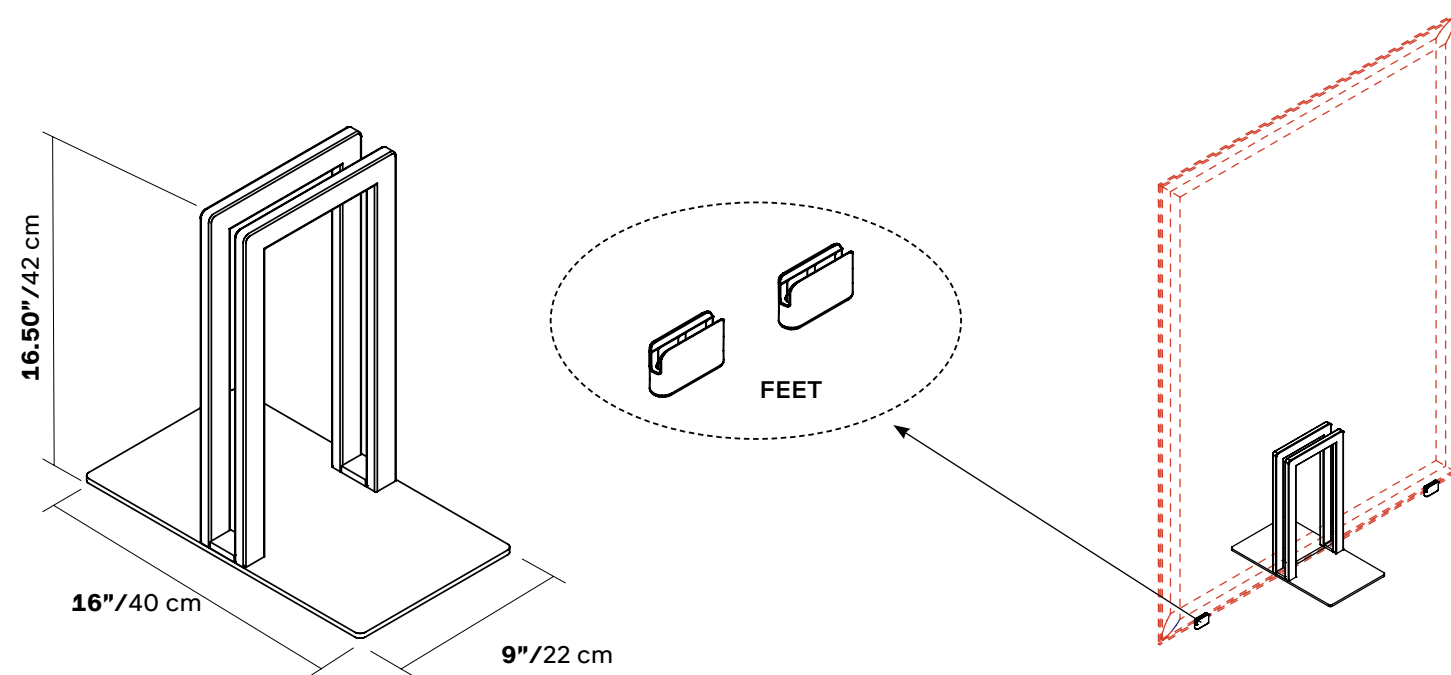

## STRAPS - OPTIONAL

| Panels  | Holds both sizes |
|---------|------------------|
| Part No | 40025133         |
| QTY     | 01 Set           |
| Finish  | Silver           |

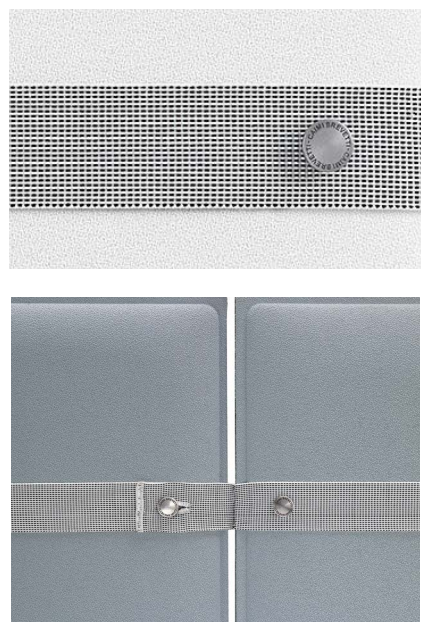
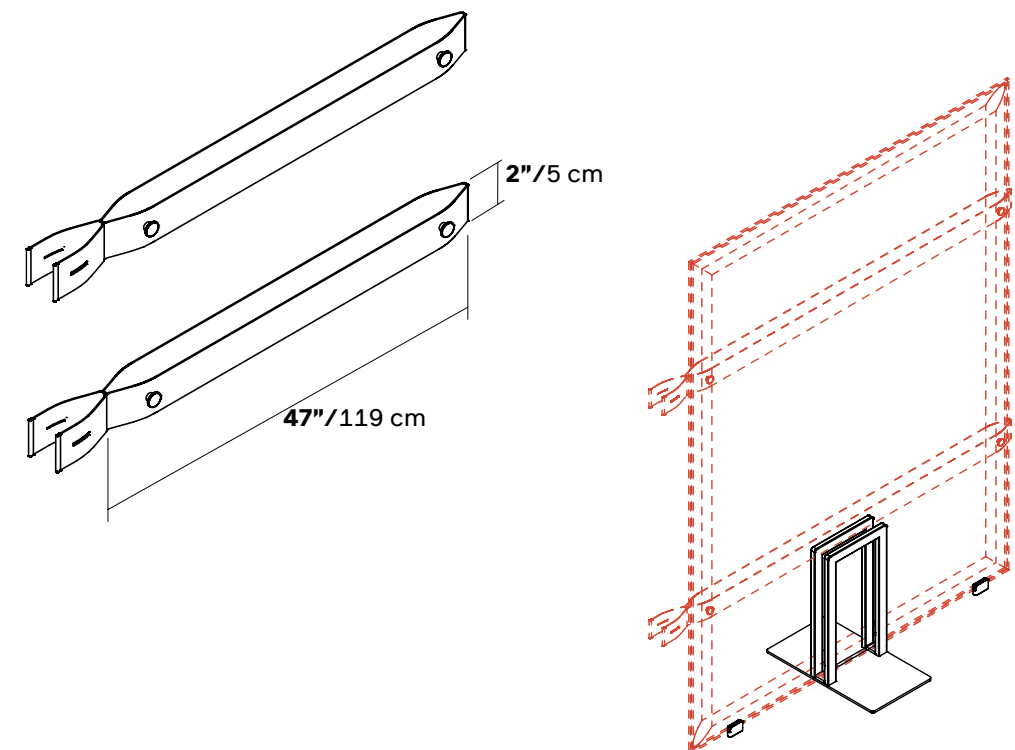

Silver

\* Panels sold separately  
 – Please choose panels on page 217