

# TRIBU



# TRI BU



TRI BU are wall-mounted acoustic panels featuring Snowcustom technology. Consisting of four panels, TRI BU can be fixed to walls in various configurations using magnets.





Specs	Polyester internal padding with Snowsound technology, polyester covering in Trevira CS® fabric
	Single material and 100% recyclable
	Eco friendly – Greenguard Gold
	Durable, tackable double-sided surface
	Patented variable density composition
	Class A sound absorption with NRC 1.0 (ISO 354/ASTM C423/ISO 11654)
	Absorbs 94% of human speech frequencies
	Class A fire and smoke safety (UL 723/ASTM E84)
	CAL 133, 117 pass
	Sleek profile at only 1.4” thick
Designer	Paola Navone – Otto Studio

# TRI BU COMPLETE KIT

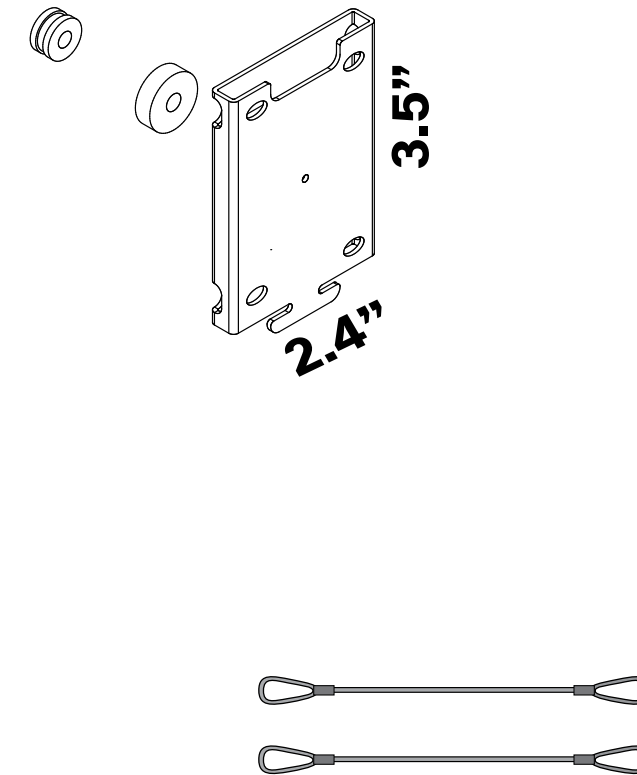
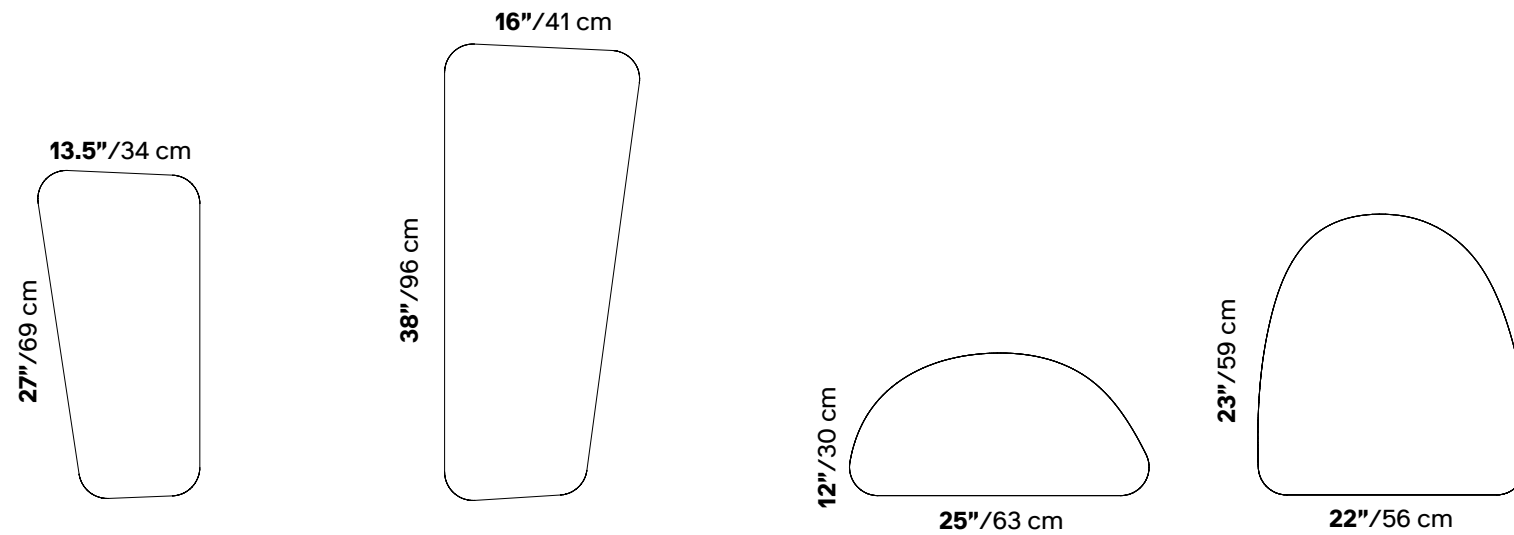
Tri Bu panels are “made-to-order.” Lead time 12 weeks (month of August excluded). Refer to pages 18 – 20 for larger swatches. Screws to fasten bracket to wall not included.

Kit includes **01 Fiber 1 textile fabric**  
**Magnetic wall connections**

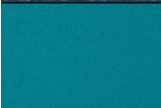

	Color	Part No	Part No	Part No	Part No
	Bright Coral	TRI1-3094		TRI4-3094	
	Blue	TRI1-6071	TRI2-6071	TRI4-6071	
	Seaside Blue		TRI2-7023		TRI3-7023
	Black	TRI1-8083			TRI3-8083

### Optional Safety Cables

Panel size	Fits All Sizes
Part No	40046007
QTY	01 Pair
Finish	Steel

For larger swatches & full color options, please refer to pages 32–34.

# TRIBU TYPICALS

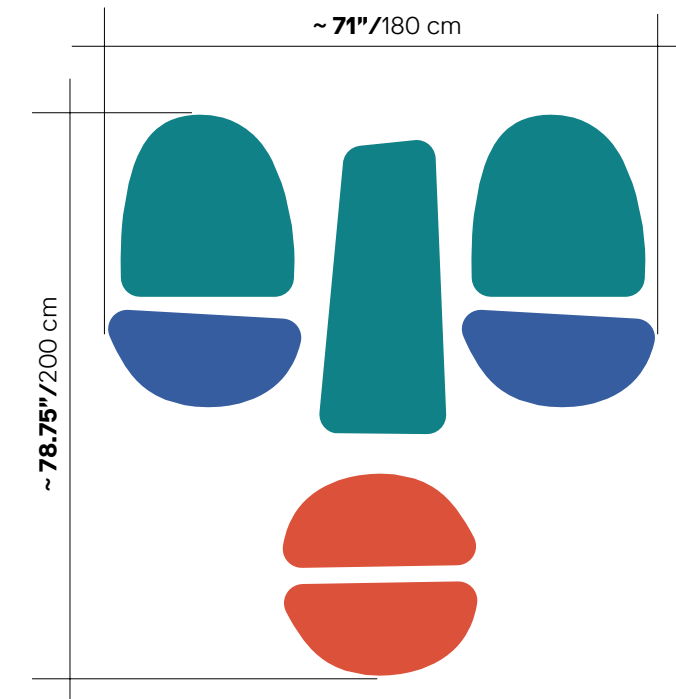
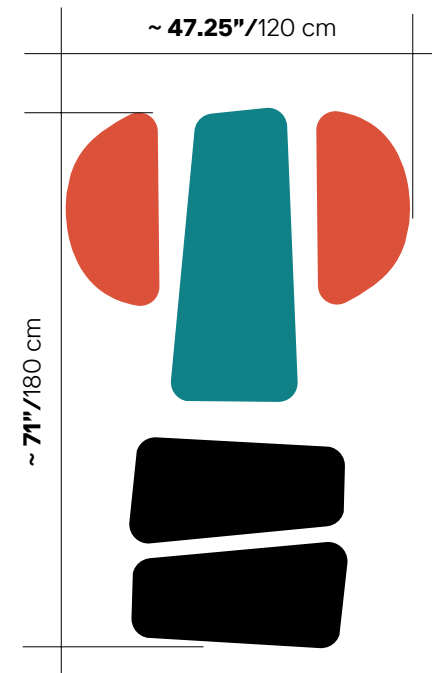
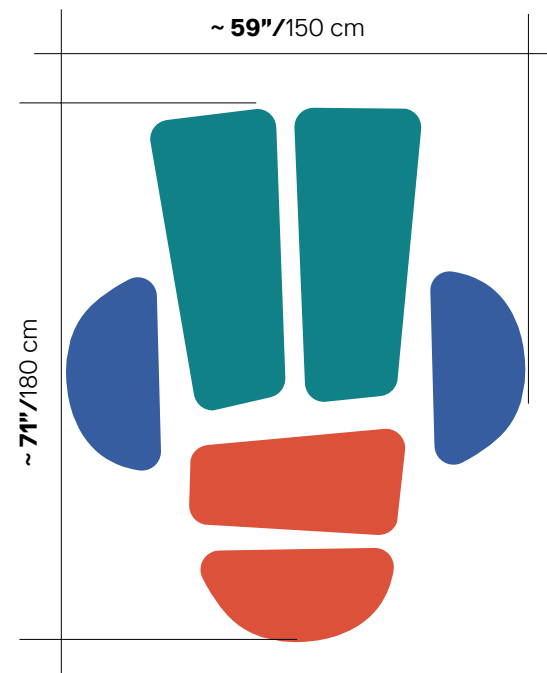
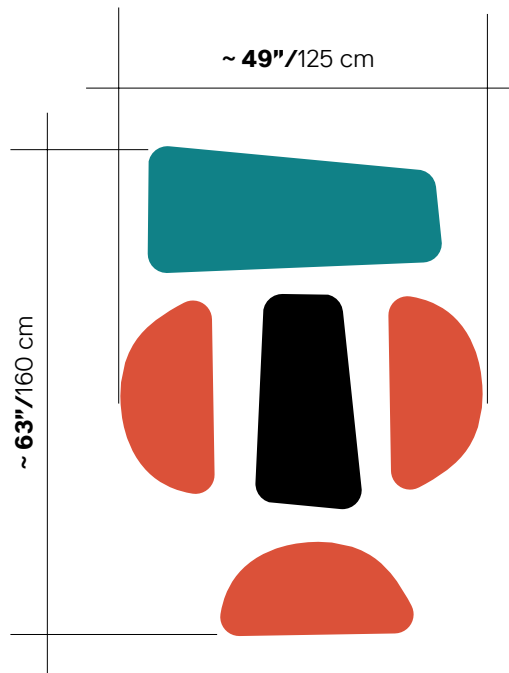
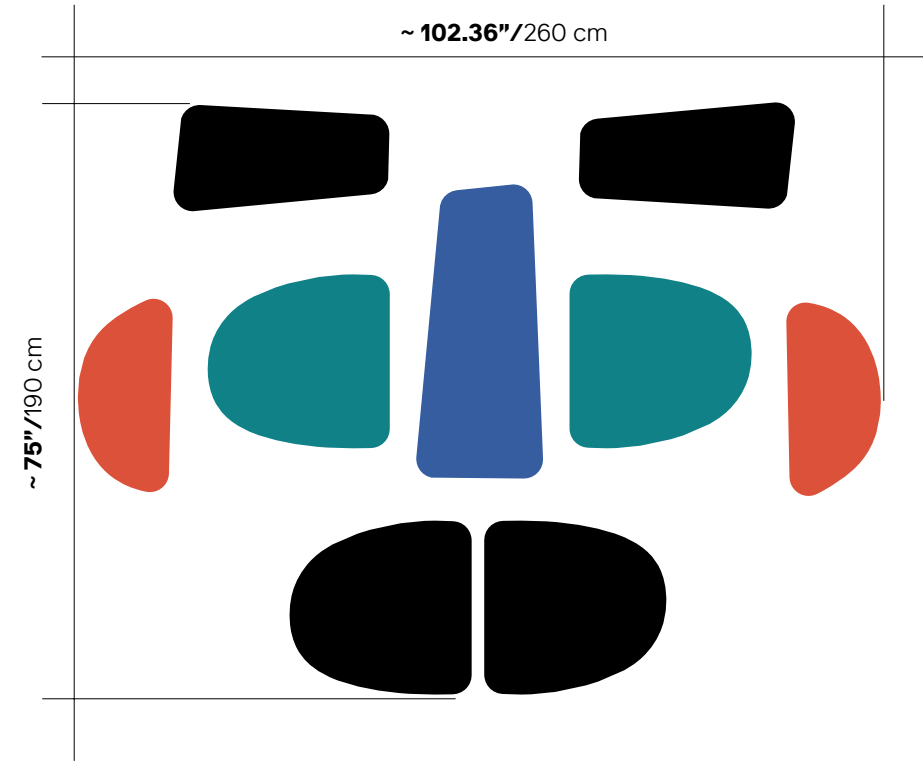
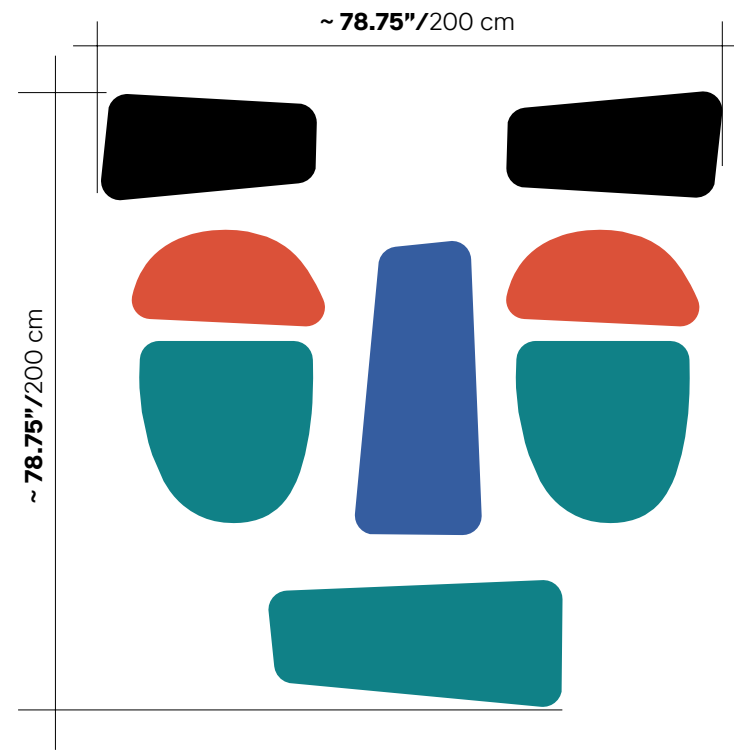
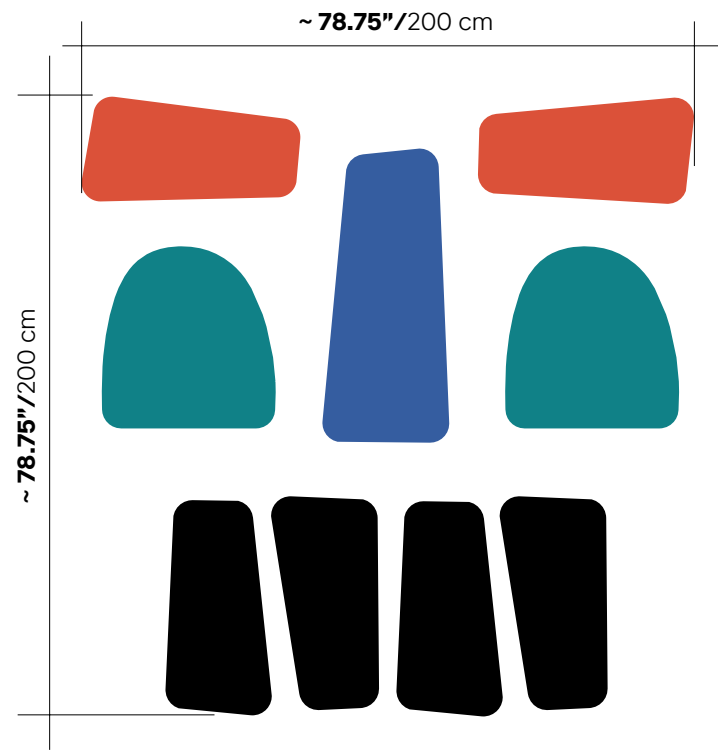

# TRI BU TYPICALS

