

# PLI OVERSIZE

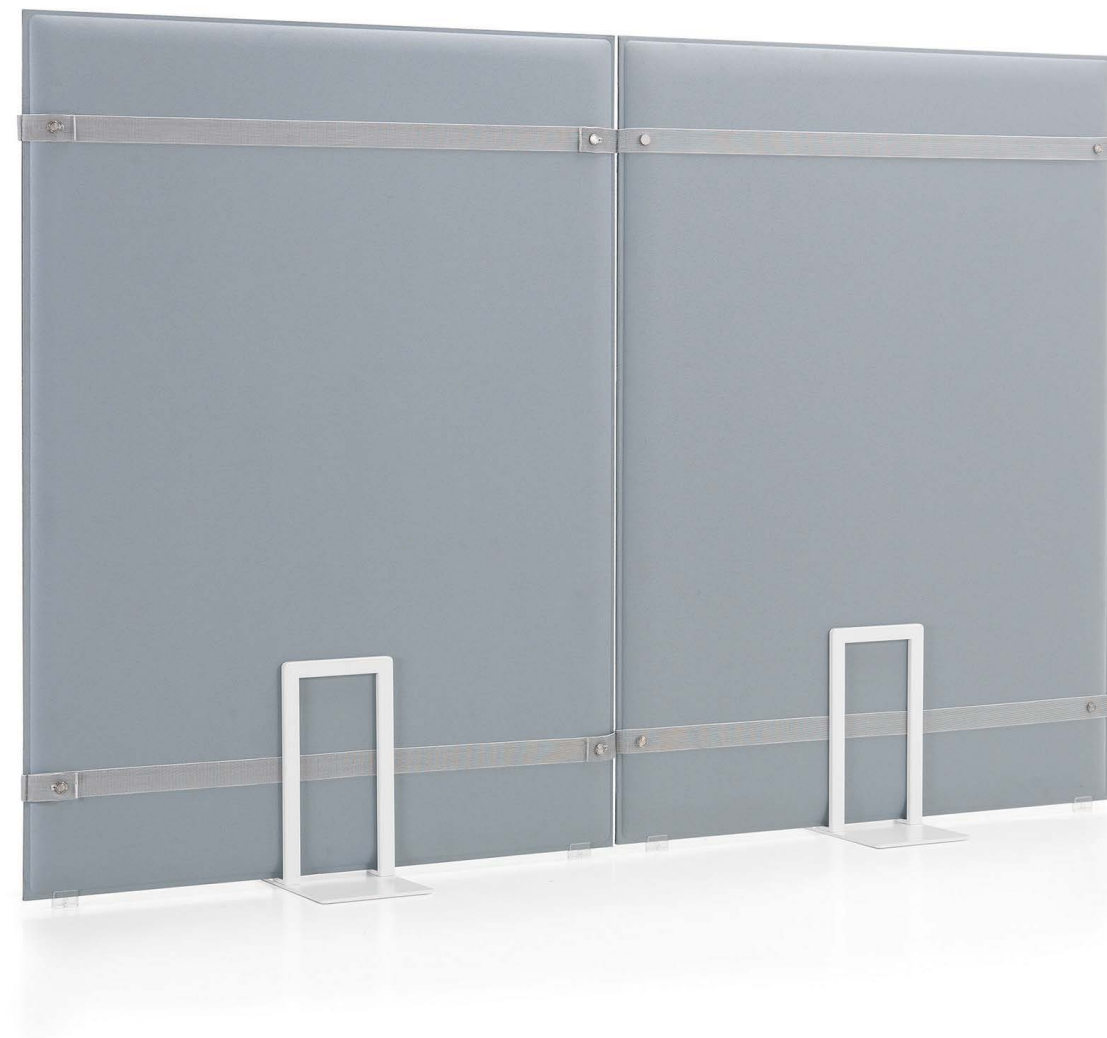

# PLI OVERSIZE

The PLI OVERSIZE system is characterized by large-size acoustic panels crafted with Snowsound® technology. These panels serve as double-sided free-standing partitions with a 1.0 NRC (Noise Reduction Coefficient).









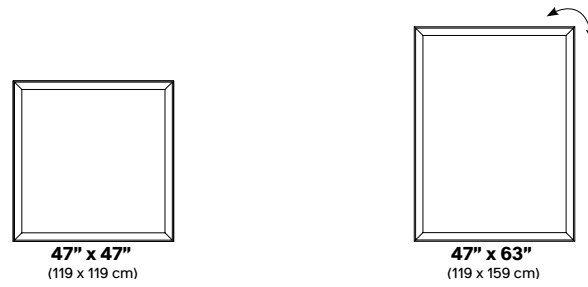

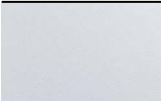
<b>Specs</b>	<b>Polyester internal padding with Snowsound technology, polyester covering in Trevira CS® fabric</b>
	<b>Single material and 100% recyclable</b>
	<b>Eco friendly – Greenguard Gold</b>
	<b>Durable, tackable double-sided surface</b>
	<b>Patented variable density composition</b>
	<b>Class A sound absorption with NRC 1.0 (ISO 354/ASTM C423/ISO 11654)</b>
	<b>Absorbs 94% of human speech frequencies</b>
	<b>Class A fire and smoke safety (UL 723/ASTM E84)</b>
	<b>CAL 133, 117 pass</b>
	<b>Sleek profile at only 1.4” thick</b>
	<b>Freestanding</b>
<b>Design</b>	<b>Marc Sadler</b>





# PLI OVERSIZE PANELS

Call your representative for stock levels and availability

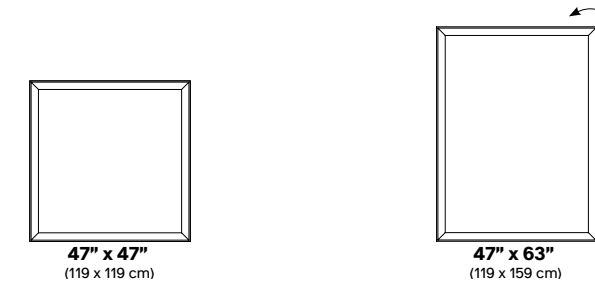

	Color	Part No	Part No
	White	40025042	40025045
	Silver Gray	40025043	40025046
	Charcoal Gray	40025082	40025080
	Slate Blue	40025299	40025300
	Beige	40025313**	40025314**
	Dove Gray	40025044**	40025047**
	Sun Yellow	40025316**	40025240**
	Carrot Orange	40025311**	40025241**
	Red	40025315**	40025284**



	Color	Part No	Part No
	Rustic Brick	40025291**	40025292**
	Olive Green	40025318**	40025319**
	Dark Teal	40025307**	40025308**
	Cool White	40025309**	40025310**
	Black	40025733**	40025734**
		Special Order Color MOQ: 18	Special Order Color MOQ: 18

\*\* Extended lead time  
 Extended lead time colors require: up to 10–12 weeks  
 For larger swatches & full color options, please refer to pages 32–34.  
 Please specify panel stand separately refer to page 144

Panels available in special order colors. Special order colors require:  
 – MOQ varies from size to size  
 – Lead time up to 14–16 weeks  
 – +10% Custom service fee

# PLI OVERSIZE

## STAND - HARDWARE ONLY

Panels	Holds both sizes	Holds both sizes
Part No	40025123	40025122
QTY	01 Stand, 02 Feet	01 Stand, 02 Feet
Finish	Silver Gray	Matte White

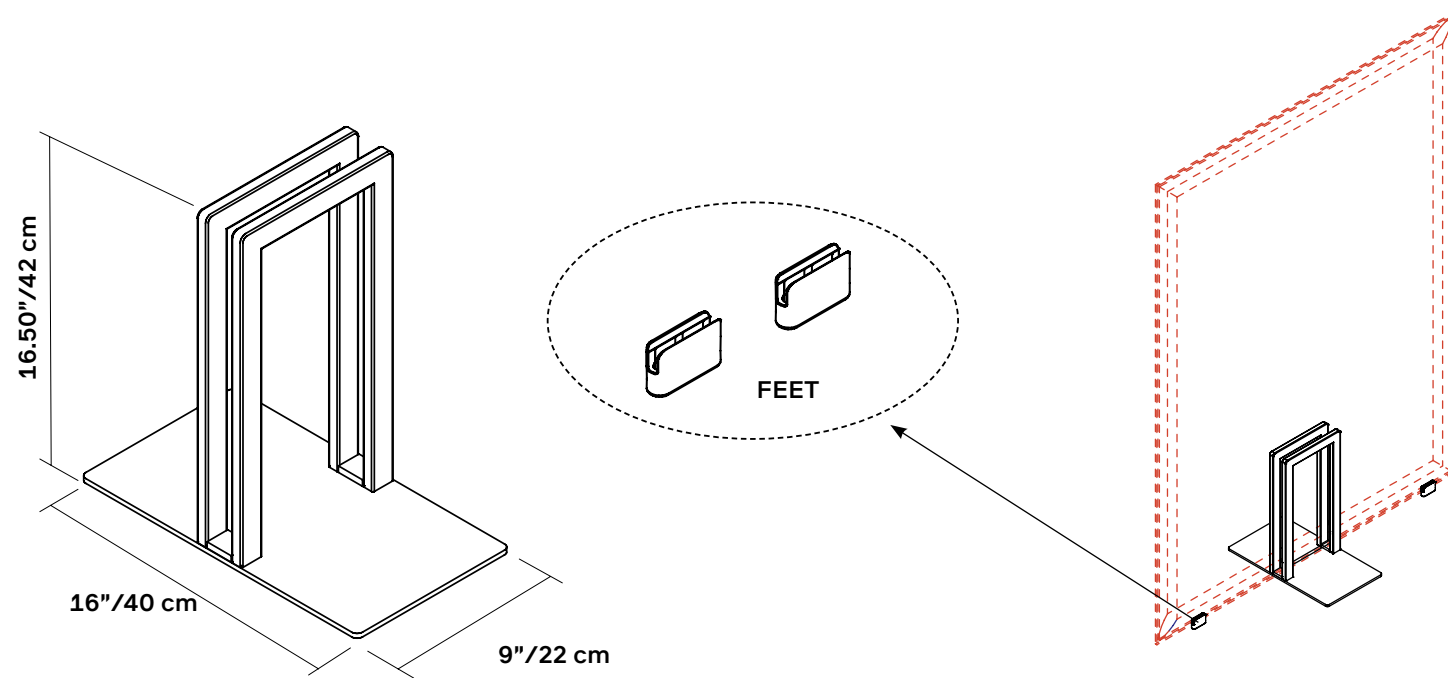

## STRAPS - OPTIONAL

Panels	Holds both sizes
Part No	40025133
QTY	01 Set
Finish	Silver

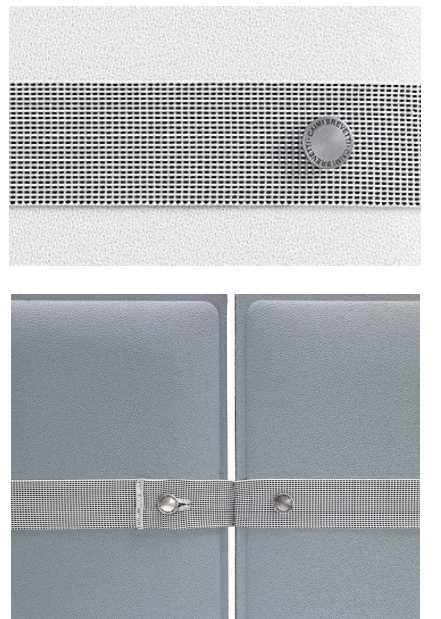
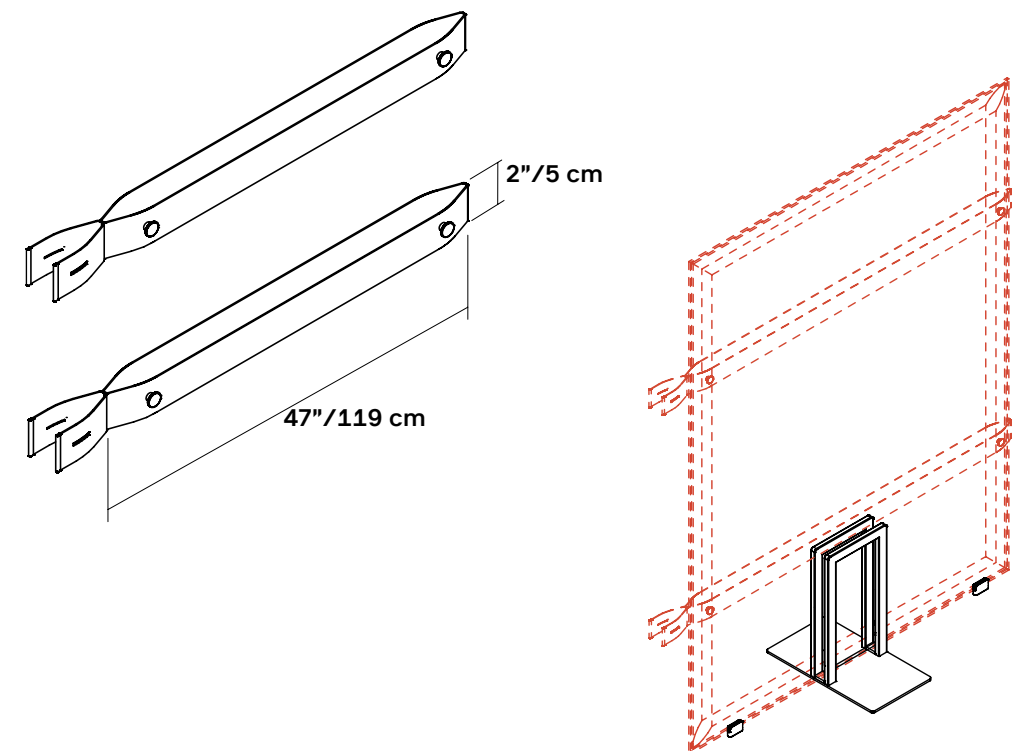

Silver

\* Panels sold separately  
 – Please choose panels on page 197