

# PLI



# PLI

The PLI panel features polyester internal padding with Snowsound® technology variable density and is covered in Trevira CS® fabric. It is designed to be used with a pair of elastic straps for connecting multiple panels together.



<b>Specs</b>	<b>Polyester internal padding with Snowsound technology, polyester covering in Trevira CS® fabric</b>
	<b>Single material and 100% recyclable</b>
	<b>Eco friendly – Greenguard Gold</b>
	<b>Durable, tackable double-sided surface</b>
	<b>Patented variable density composition</b>
	<b>Class A sound absorption with NRC 1.0 (ISO 354/ASTM C423/ISO 11654)</b>
	<b>Absorbs 94% of human speech frequencies</b>
	<b>Class A fire and smoke safety (UL 723/ASTM E84)</b>
	<b>CAL 133, 117 pass</b>
	<b>Sleek profile at only 1.4” thick</b>
	<b>Freestanding</b>
<b>Design</b>	<b>Marc Sadler</b>

# PLI PANELS

Call your representative for stock levels and availability

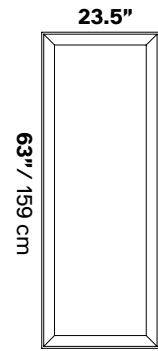

Color	Part No
White	40025002
Silver Gray	40025001
Charcoal Gray	40025003
Slate Blue	40025295
Beige	40020055
Dove Gray	40025004
Sun Yellow	40020056**
Carrot Orange	40025006
Red	40020057

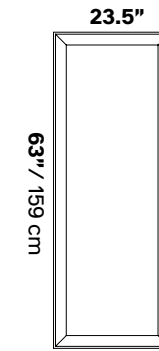

Color	Part No
Rustic Brick	40025287**
Olive Green	40020058
Dark Teal	40025303**
Cool White	40025664**
Blue	40025005

Special Order Color  
MOQ: 50

\*\* Extended lead time  
Extended lead time colors require: up to 10–12 weeks  
For larger swatches & full color options, please refer to pages 32–34.

Panels available in special order colors. Special order colors require:  
– MOQ varies from size to size,  
– Lead time up to 14–16 weeks  
– +10% Custom service fee

# PLI PANELS



Kit includes

02 Connection straps

02 Support feet

## CONNECTION STRAPS - PAIR

Each set of connection straps and support feet are for 1 PLI panel

	Finish	Panels	Part No	Qty
	Black	23.5" x 63"	40025135	01 Set
	Silver	23.5" x 63"	40025134	01 Set
	Brown	23.5" x 63"	40025136	01 Set

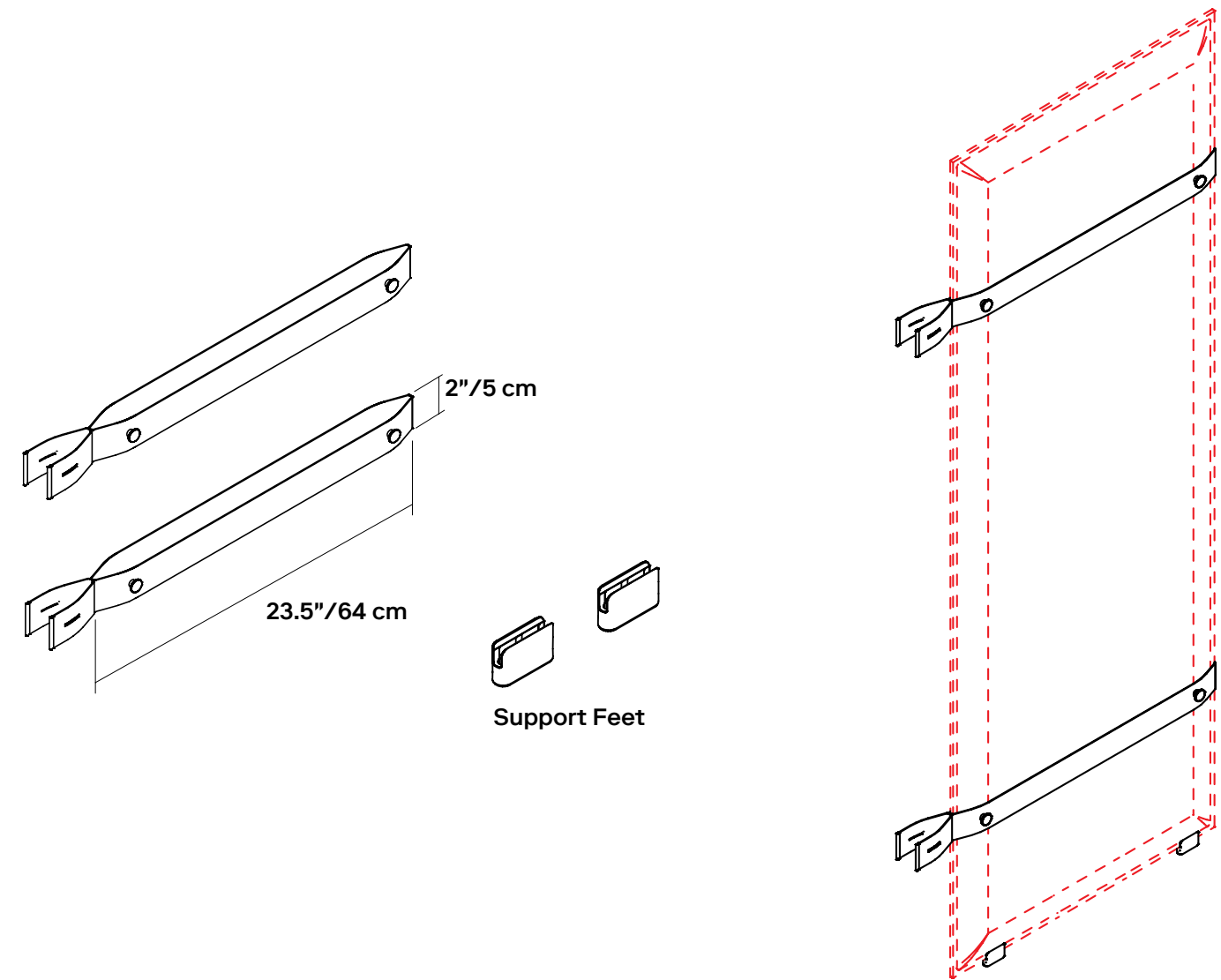

# PLI PANELS

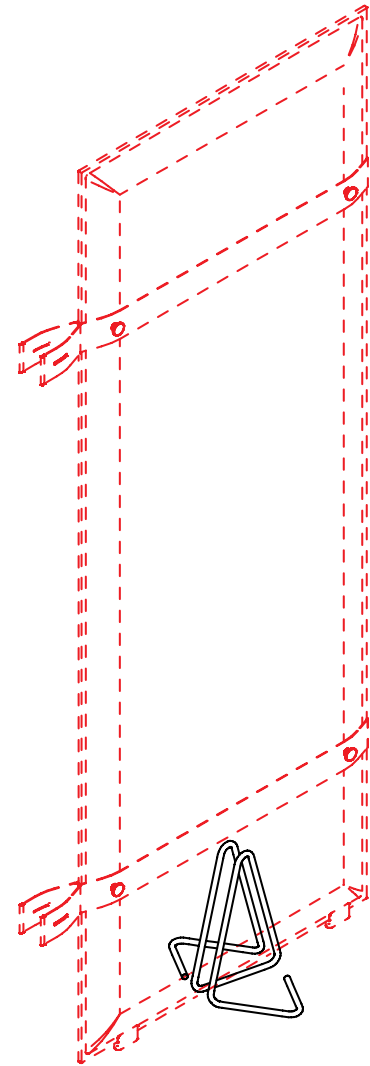

## SUPPORT BASE - BASE ONLY

Base and support feet are for 1 PLI panel

Panel Size	23.5" x 63"
Part No	40024029
QTY	01
Finish	Chrome

Kit includes	01 Support Base
	02 Support Feet

