

CLIMBING



CLIMBING



CLIMBING (WALL MOUNTED) is an organic system that offers free combinability, transcending the rules of regularity. Formally and conceptually inspired by nature, it creates unique and diverse surfaces. The volumes, reminiscent of pebbles and stone walls, generate a distinct and irregular interplay of light, enhancing acoustic performance.

Specs	Single material and 100% recyclable
	Eco friendly – Greenguard Gold
	Class A sound absorption with (ISO 354)
	Class A fire and smoke safety (UL 723/ASTM E84)
	CAL 133, 117 pass
	Wall mounted
Design	Rafaello Manzoni

CLIMBING COMPLETE KIT FIBER 3

Call your representative for stock levels and availability.

Climbing panels are “made-to-order.” Lead time 12 weeks (month of August excluded). Final screws to fasten bracket to wall not included.

Kit includes	01 Climbing panel
	Magnetic mounting brackets

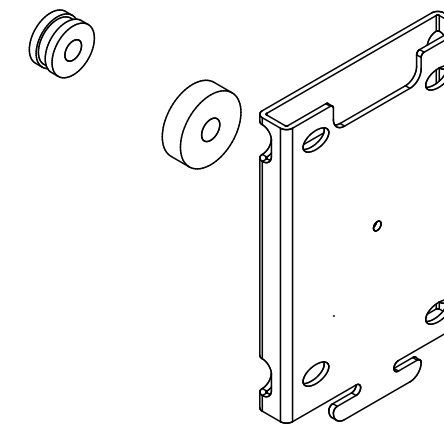
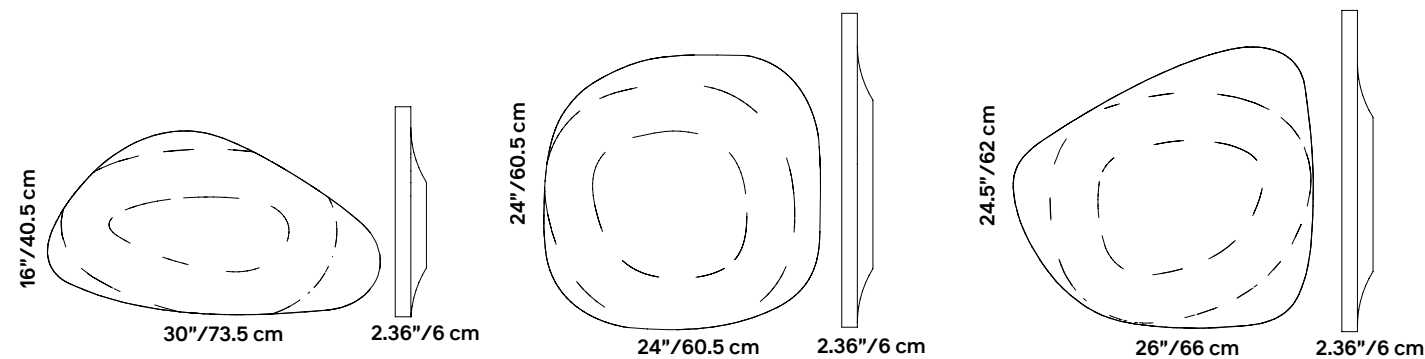

	Color	Part No	Part No	Part No
	300 Gray Ice	CLM1F3-300	CLM2F3-300	CLM3F3-300
	305 Anthracite	CLM1F3-302	CLM2F3-302	CLM3F3-302
	309 Gray Green	CLM1F3-309	CLM2F3-309	CLM3F3-309
	311 Carbon Gray	CLM1F3-311	CLM2F3-311	CLM3F3-311
	312 Patina	CLM1F3-312	CLM2F3-312	CLM3F3-312
	313 Evergreen	CLM1F3-313	CLM2F3-313	CLM3F3-313



Optional Safety Cables

Panel size	Fits All Sizes
Part No	40046007
QTY	01 Pair
Finish	Steel

For larger swatches & full color options, please refer to pages 277-280.