

**SNOWSOUND®**  
Acoustics & Well-Being Technologies

# PERLINE TOTEM

Design: A+B Dominoni. Quaquaro

Distributed by Snowsound USA

MOD. 565-A/LO

(x = color alternative)

40051xxx

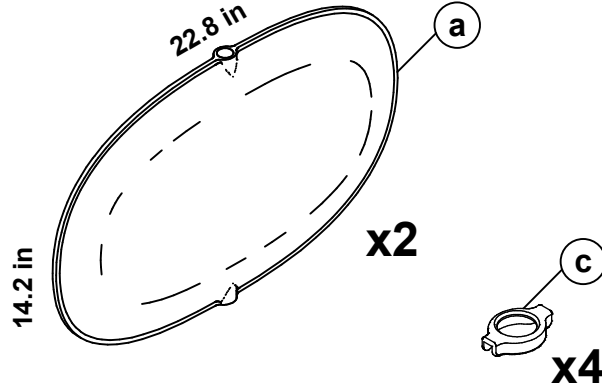

40051017

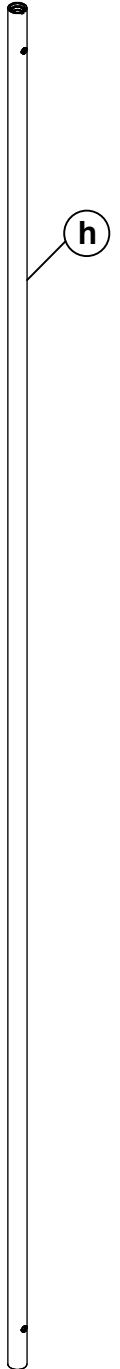

40051xxx

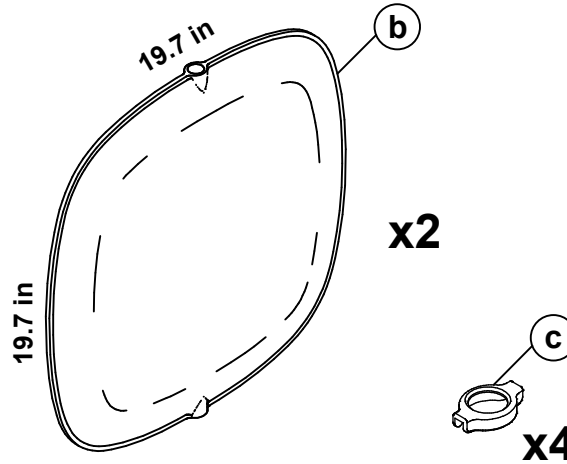

40051xxx

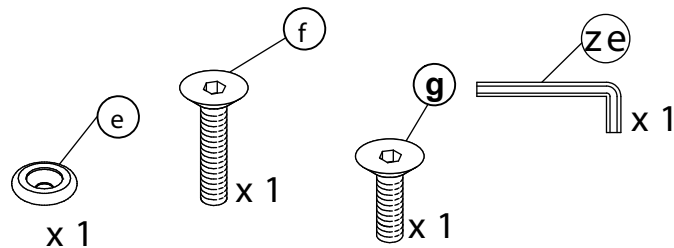
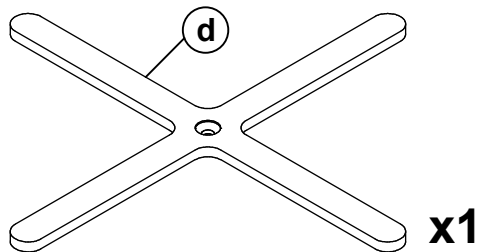

40051052

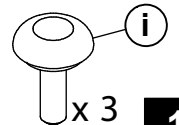

1

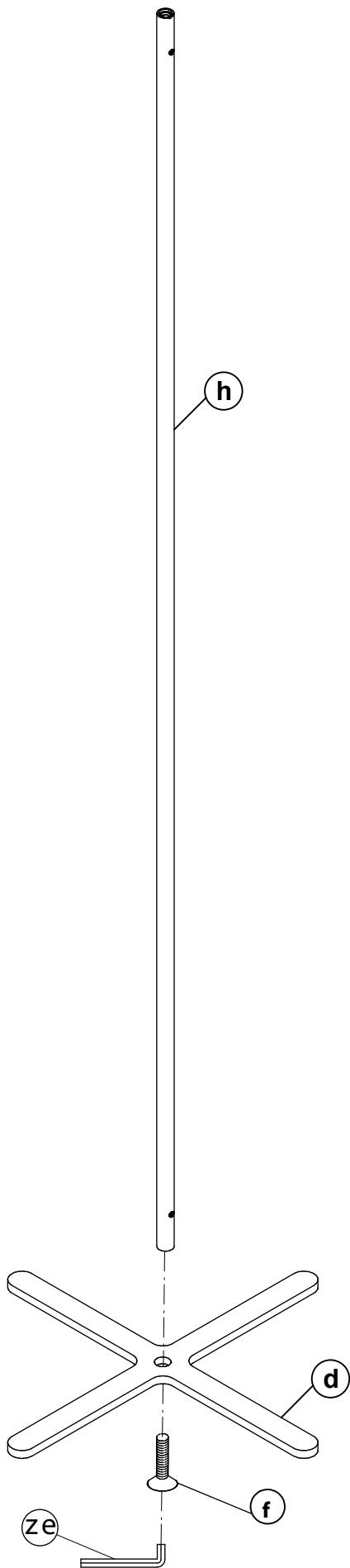

2

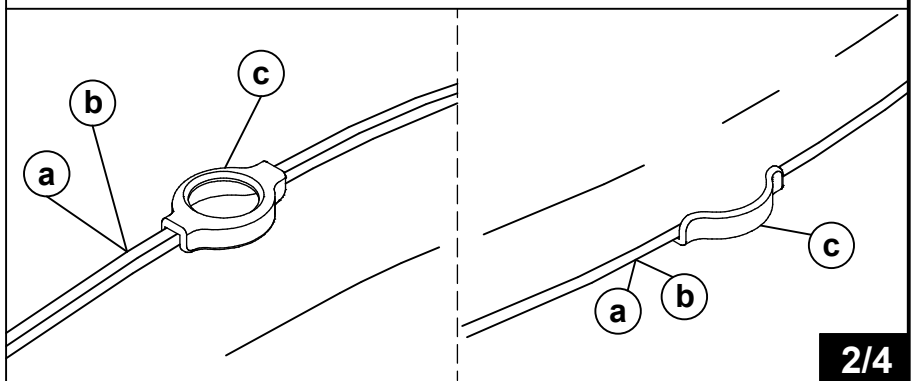
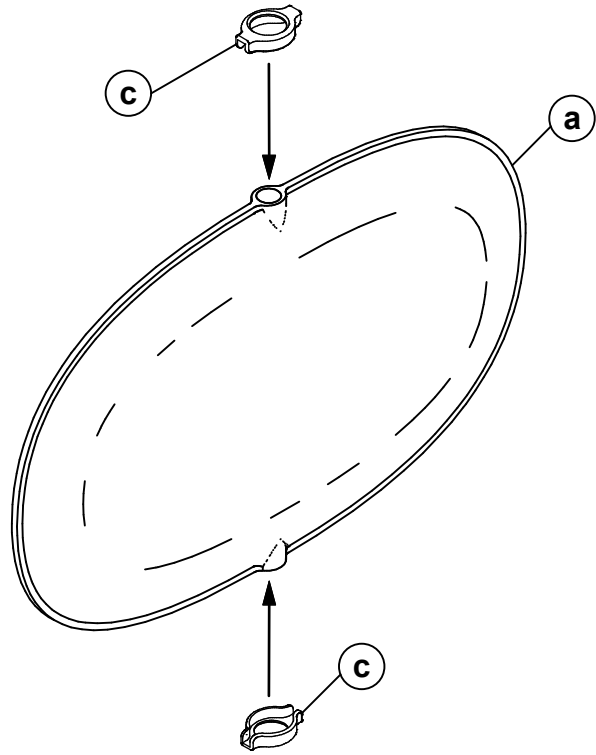

3

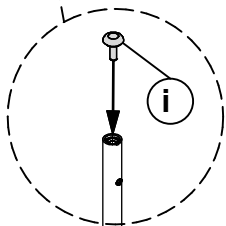
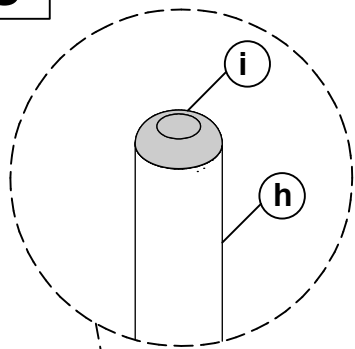

h

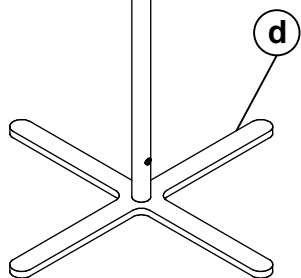

4

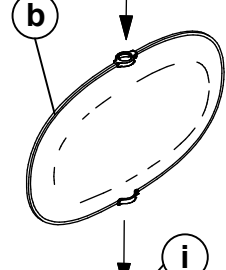
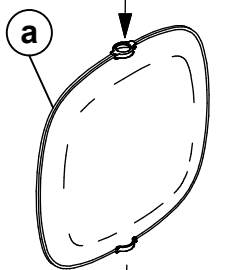
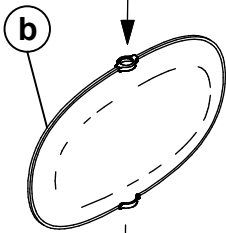
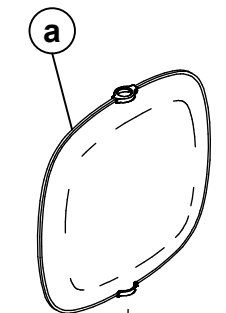

h

d

5

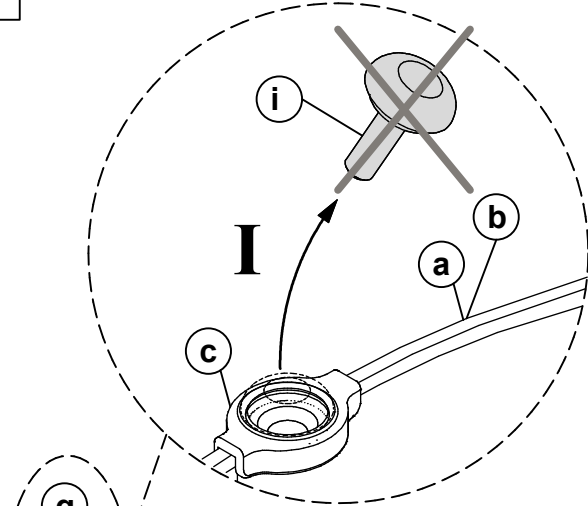

I

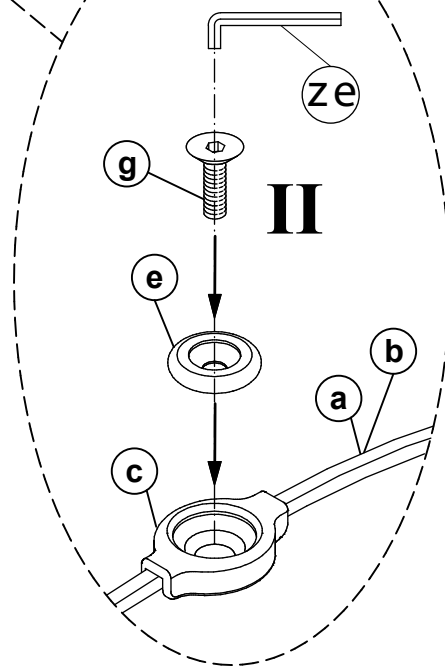
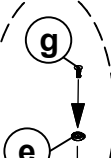
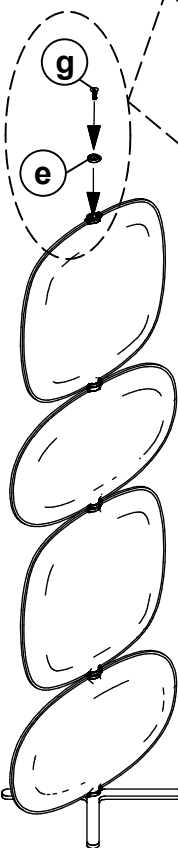

II

6

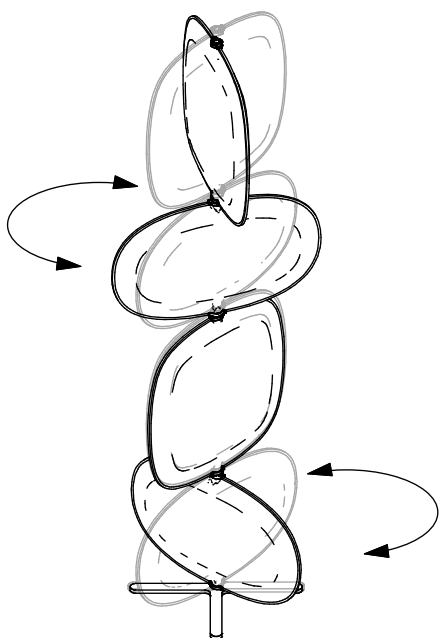

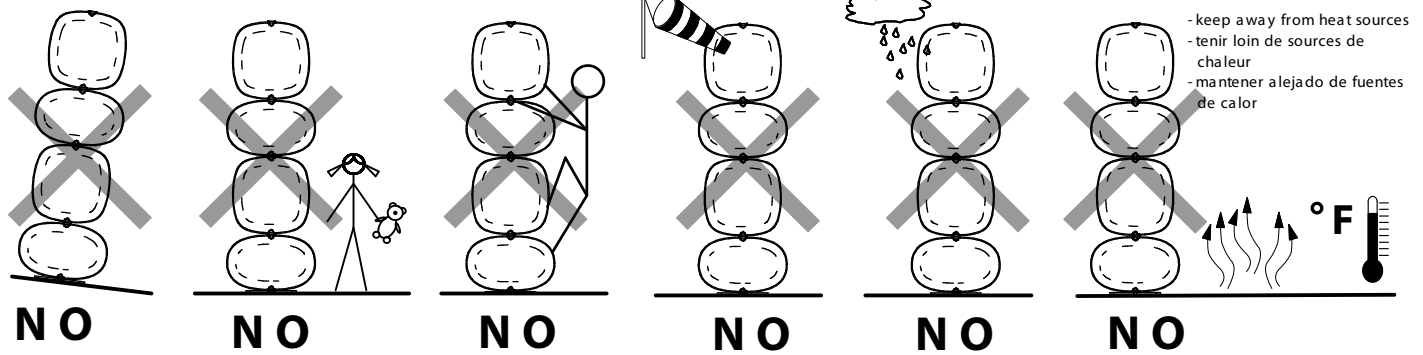

Congratulations on your latest SNOWSOUND purchase. Follow these instructions and you'll have this new product mounted in no time. If you need any help, or to order replacement/missing parts, please call **1-800-747-2660** or email "**info@snowsoundusa.com**"

**NOTE!**

**Prior to assembling and installing the unit please read the following notes carefully. Pay particular attention to the drawings in the assembly instructions. Please consult these notes every time the product is assembled and/or installed.**

1. The product must only be assembled and installed by qualified contractors. Warning: once the product has been assembled always check that the structure is suitable for the type of application and/or use to which it will be put. These products are not suitable for use by children.
2. Prior to installation check the load bearing capacity of the surface on which the product is to be fitted :use suitable fixtures according to the type of surface which must be able to withstand the forces generated.
3. Warning: if you have any doubts concerning how to install the product and/or the load bearing capacity of the surface on which it will fitted,do not fit it.
4. Do not use detergents to clean the parts that are not in textile fabric.
5. To clean the panel use only a dry stain removal, carefully following the instructions on the product used.
6. For further information on how to install the product,please contact your dealer. For any use different from the ones here shown please contact the dealer.
7. To complete the assembling of the products please follow the instructions related to the chosen support