

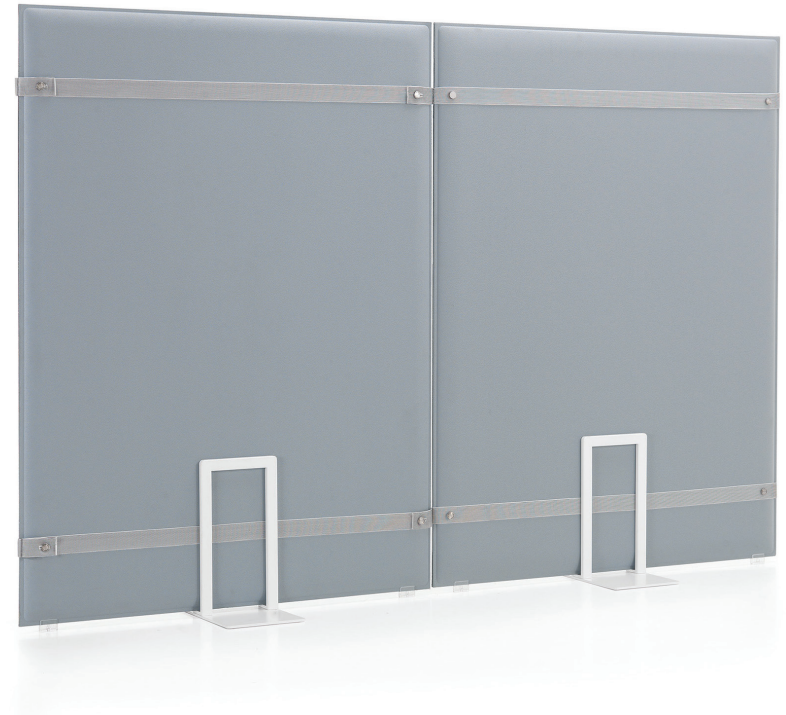















### PLI OVERSIZE

The PLI OVERSIZE system is characterized by the large size acoustic panel proportion made with Snowsound® technology. Panels serve as double-sided free-standing 1.0 NRC partitions.



- Polyester internal padding with Snowsound technology, polyester covering in Trevira CS® fabric
- Single material and 100% recyclable
- Eco friendly - Greenguard Gold
- Durable, tackable double-sided surface
- Patented variable density composition
- Class A sound absorption with NRC 1.0 (ISO 354/ASTM C423/ISO 11654)
- Absorbs 94% of human speech frequencies
- Class A fire and smoke safety (UL 723/ASTM E84)
- CAL 133, 117 pass
- Sleek profile at only 1.4" thick
- Freestanding

47" x 47" - PANEL ONLY

QUICK SHIP	COLOR	PART #	EXT. LEAD TIME	COLOR	PART #	EXT. LEAD TIME	COLOR	PART #
	WHITE	40025042		COOL WHITE	40025309		RUSTIC BRICK	40025291
	SILVER GRAY	40025043		BEIGE	40025313		OLIVE GREEN	40025318
	CHARCOAL GRAY	40025082		SUN YELLOW	40025316		DARK TEAL	40025307
	SLATE BLUE	40025299		CARROT ORANGE	40025311		DOVE GRAY	40025044
				RED	40025315		BLACK	40025733

EXTENDED LEAD TIME COLORS REQUIRE:

- LEAD TIME UP TO 10-12 WEEKS

Call your local representative for stock levels and availability





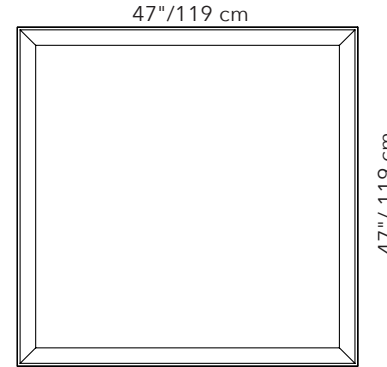









PANELS AVAILABLE IN SPECIAL ORDER COLORS. PLEASE REFER TO THE COLOR OPTIONS ON PAGES 6, 7 & 8. SPECIAL ORDER COLORS REQUIRE:

- MINIMUM ORDER QUANTITY 18 PER COLOR
- LEAD TIME UP TO 14-16 WEEKS
- +10% CUSTOM SERVICE FEE



PLEASE SPECIFY PANEL STAND SEPARATELY  
REFER TO PAGE: 100

47" x 63" - PANEL ONLY

QUICK SHIP	COLOR	PART #	EXT. LEAD TIME	COLOR	PART #	EXT. LEAD TIME	COLOR	PART #
	WHITE	40025045		COOL WHITE	40025310		RUSTIC BRICK	40025292
	SILVER GRAY	40025046		BEIGE	40025314		OLIVE GREEN	40025319
	SLATE BLUE	40025300		SUN YELLOW	40025317		DARK TEAL	40025308
	CHARCOAL GRAY	40025080		CARROT ORANGE	40025312		DOVE GRAY	40025047
				RED	40025284		BLACK	40025247

EXTENDED LEAD TIME COLORS REQUIRE:

- LEAD TIME UP TO 10-12 WEEKS

Call your local representative for stock levels and availability

PANELS AVAILABLE IN SPECIAL ORDER COLORS. PLEASE REFER TO THE COLOR OPTIONS ON PAGES 6, 7 & 8. SPECIAL ORDER COLORS REQUIRE:

- MINIMUM ORDER QUANTITY 18 PER COLOR
- LEAD TIME UP TO 14-16 WEEKS
- +10% CUSTOM SERVICE FEE

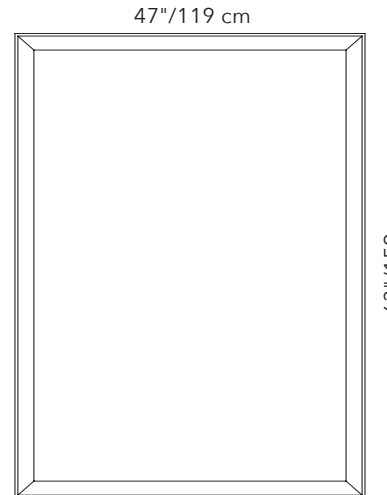

PLEASE SPECIFY PANEL STAND SEPARATELY  
REFER TO PAGE: 100

**STAND - HARDWARE ONLY**

PANEL SIZE	PART #	QTY	FINISH
BOTH SIZES	40025123	1 STAND, 2 FEET	SILVER GRAY
BOTH SIZES	40025122	1 STAND, 2 FEET	MATTE WHITE

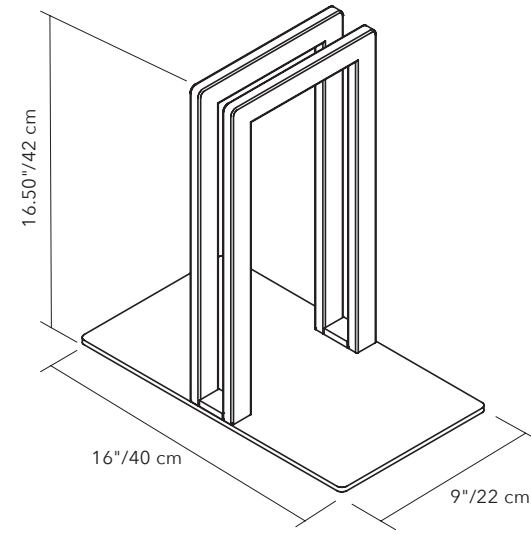
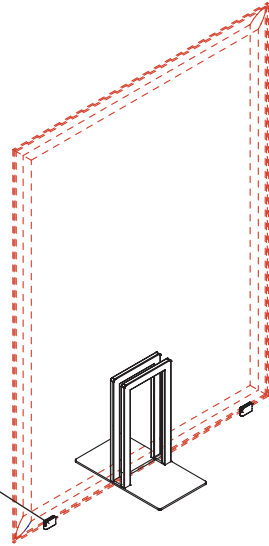
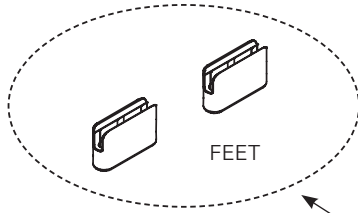

**STRAPS - STRAPS OPTIONAL**

PANEL SIZE	PART #	QTY	COLOR
BOTH SIZES	40025133	1 SET OF STRAPS	SILVER

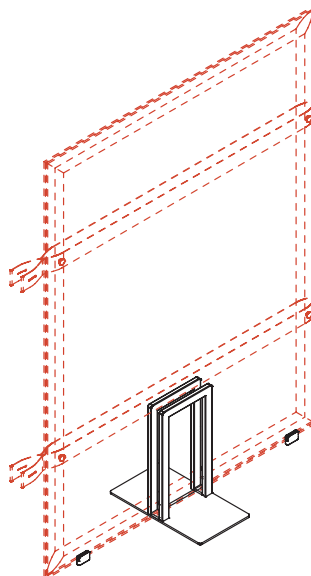
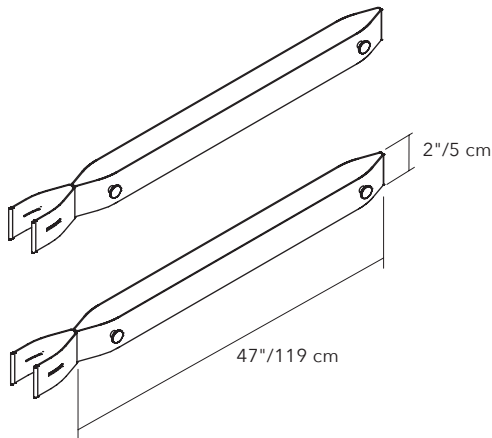

Silver

