













**PLI**

PLI panel with polyester internal padding with Snowsound® technology variable density. Polyester covering in Trevira CS® Fabric. To be used with pair of elastic straps for connecting multiple panels together.



- Polyester internal padding with Snowsound technology, polyester covering in Trevira CS® fabric
- Single material and 100% recyclable
- Eco friendly - Greenguard Gold
- Durable, tackable double-sided surface
- Patented variable density composition
- Class A sound absorption with NRC 1.0 (ISO 354/ASTM C423/ISO 11654)
- Absorbs 94% of human speech frequencies
- Class A fire and smoke safety (UL 723/ASTM E84)
- CAL 133, 117 pass
- Sleek profile at only 1.4" thick
- Freestanding

23.5"x 63" - PANEL ONLY

QUICK SHIP	COLOR	PART #	QUICK SHIP	COLOR	PART #	EXT. LEAD TIME	COLOR	PART #
	WHITE	40025002		OLIVE GREEN	40020058		SUN YELLOW	40020056
	SILVER GRAY	40025001		BEIGE	40020055		RUSTIC BRICK	40025287
	CHARCOAL GRAY	40025003		DOVE GRAY	40025004		DARK TEAL	40025303
	CARROT ORANGE	40025006		BLUE SLATE	40025295		COOL WHITE	40025664
	RED	40020057		BLUE	40025005			

EXTENDED LEAD TIME COLORS REQUIRE:

- LEAD TIME UP TO 10-12 WEEKS

Call your local representative for stock levels and availability

PANELS AVAILABLE IN SPECIAL ORDER COLORS.

PLEASE REFER TO THE COLOR OPTIONS ON PAGES 6, 7 & 8. SPECIAL ORDER COLORS REQUIRE:

- MINIMUM ORDER QUANTITY 50 PER COLOR
- LEAD TIME UP TO 14-16 WEEKS
- +10% CUSTOM SERVICE FEE

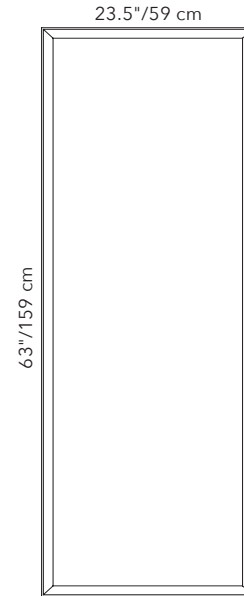

CONNECTION STRAPS - PAIR

PANEL SIZE	PART #	QTY	COLOR
23.5"x 63"	40025135	1 SET	BLACK
23.5"x 63"	40025134	1 SET	SILVER
23.5"x 63"	40025136	1 SET	BROWN

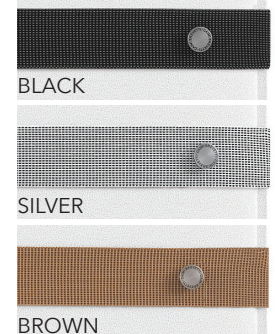
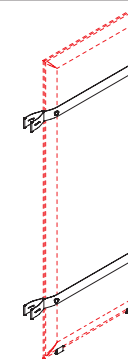
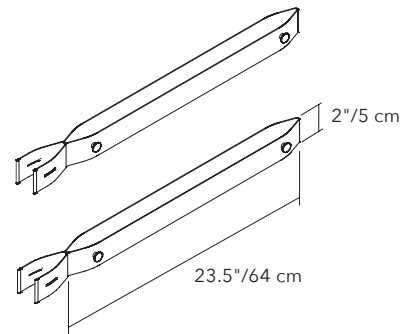

Includes: (2) Connection straps, and (2) Support Feet

EACH SET OF CONNECTION STRAPS AND SUPPORT FEET ARE FOR 1 PLI PANEL

SUPPORT BASE - BASE ONLY

PANEL SIZE	PART #	QTY	FINISH
23.5"x 63"	40024029	1	CHROME

Includes: (1) Support Base, and (2) Support Feet

BASE AND SUPPORT FEET ARE FOR 1 PLI PANEL

